

SAMSUNG

SAMSUNG CAMERA

User Manual

Digital Camera

Digimax 410

Digimax 340

Thank you for buying a Samsung Camera. This manual will guide you through using the **Digimax 410/Digimax 340**, including taking images, downloading images and using MGI PhotoSuite III SE software. Please read this manual before using your new camera.

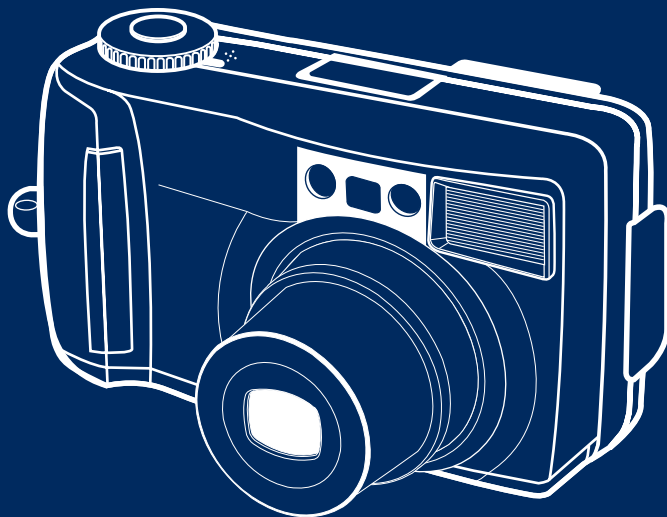

ENGLISH



SPECIAL FEATURES

Thank you for buying a Samsung Digital Camera.
This digital camera has the following features.

- ▶ Digimax 410 : A high resolution of 4.0 mega pixels
Digimax 340 : A high resolution of 3.2 mega pixels
- ▶ A 3 X optical and 2 X digital zoom lens
- ▶ Movie clip recording function
- ▶ Voice Recording & Playback for still image
- ▶ An easy and fast PC interface with USB Storage Driver & Digimax viewer

An FCC warning

- This device has been tested in accordance with the limits of a class B digital device under item 15 of the FCC rules. These limits are designed to provide protection against harmful interference in commercial installation.
This equipment generates, absorbs and can emit radio frequency energy. If it is not installed and used in accordance with the instructions, it may cause harmful interference to radio communication.
There is however, no guarantee that interference will not occur in some situations. Should any interference occur when this device is in operation, please try one or more of the following measures.
 - Change the location and direction of any aerial.
 - Increase distance between camera and affected device.
 - Use a different socket away from the affected device.
 - Please contact a Samsung agent or a radio/TV engineer.
- This device complies with part 15 of the FCC Rules.



MANUFACTURER'S CONTENTS

READY

Manufacturer's contents

Please check that you have the correct contents before using this product.

Digital camera



CompactFlash™ card (CF CARD)



4 AA Alkaline Batteries

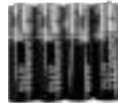

Pouch



Video cable



USB cable



Camera strap



Applications S/W,
Driver CD-ROM



User manual



Product warranty



Accessories (optional)



AC Adapter



THIS DIGITAL CAMERA CAN BE USED FOR



Viewing images
on TV

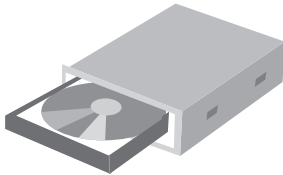

Recording images
onto CD

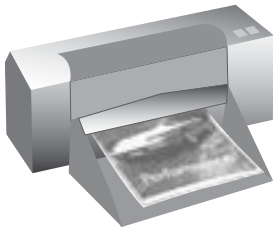

Printing images



Editing images
on a PC



THIS DIGITAL CAMERA CAN BE USED FOR

READY

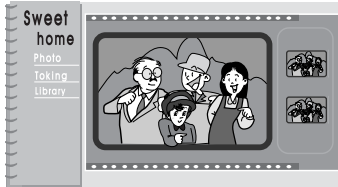

Creation of
a digital photo album



Inserting images
directly into any
electronic document

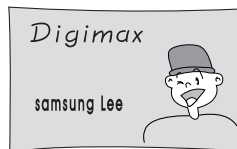

Taking a self-portrait
and using the image
to personalize name
cards

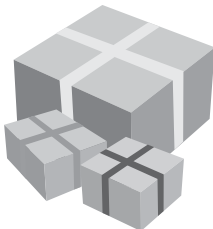

You can even create your
own unique gift-wrap paper
by using your digital
images.



CONTENTS

Ready

- Getting to Know your camera 7
- Safety note 8
- Identification of features 10
 - Product Exterior 10
 - Viewfinder 12
 - LCD panel indicator 14
 - LCD monitor indicator 15
 - LCD monitor menu indicator 17
- Preparation 19
 - Connecting to Power 19
 - Using the batteries 19
 - Using the AC power adapter 20
 - Attaching the strap 20
 - Inserting the CF CARD 21
 - Removing the CF CARD 21
 - Instructions on how to use the CF CARD 23
 - Selecting the date and time 24

Advanced

- Camera working mode 26
- Taking photos 27
- Setting up the shooting function 30
 - Movie clip shot 30
 - Using the camera buttons to adjust the camera 31
 - Using the LCD monitor to adjust the camera 38
- Setting up play back functions 53
 - Starting play mode 53

- Setting up play function
 - by using the camera button 54
 - Setting up play back function using the LCD monitor 59
- Setting up the camera system 65
 - Starting Set up mode 65
- Connecting to an external monitor 74
- PC mode 75
- Important notes 76
 - Caution 76
 - Warning indicator 78
- Before contacting a service center 79
- Specification 82

Software

- Software manual 84
- How to set up the software for Windows 85
 - Setting up USB driver for Windows 86
 - Setting up DirectX 8.1 for windows 88
 - Setting up Digimax Viewer 90
 - Setting up the MGI PhotoSuite III SE 92
- Connecting the camera for Windows 95
- Removable Disk 95
- How to use the software 97
 - Digimax Viewer 97
 - MGI PhotoSuite III SE 98
- Removing USB Driver for Windows 111
- Connecting the camera for MAC 113
- How to install and use the USB driver for MAC 114
- FAQ 115



GETTING TO KNOW YOUR CAMERA

- Prior to using this camera, please read the user manual thoroughly.
- Keep the manual in a safe place.

Symbol Explanations

This manual contains instructions on using this camera that will help you to use this camera safely and correctly. This will help prevent danger and injury to others.



Warning

This is a descriptive statement warning of the result if the instructions are ignored or not understood.



Note

This explains use of the camera, please refer to this.



Reference

This should further assist camera operation.



SAFETY NOTE

WARNING

- Do not attempt to modify this camera in any way. This may result in fire, injury, electric shock or severe damage to you or your camera. Internal inspection, maintenance and repairs should be carried out by your dealer or Samsung Camera Service Center.
- Do not use the flash in close proximity to the people or animals. Positioning the flash too close to your subject's eyes, may cause eyesight damage. Do not attempt to photograph children using a flash closer than 1 meter proximity.
- When taking photographs, never point the lens of the camera directly into very strong light. This may result in permanent damage to the camera or your eyesight.
- Please do not use this product in close proximity to flammable or explosive gases, as this could increase the risk of explosion.
- For safety reasons keep this product and accessories out of reach of children or animals to prevent accidents e.g.:
 - Swallowing batteries or small camera accessories.
In case of accidents, please consult a doctor immediately.
 - There is a risk of permanent eye damage if the flash is operated at a distance of less than one meter from a person's eyes.
 - There is a possibility of injury from the camera's moving parts.
- Should any form of liquid enter the camera, do not use it. Switch off the camera, and then disconnect the power source (batteries or AC Power Adapter). You must contact your dealer or Samsung Camera Service Center. Do not continue to use the camera as this may cause a fire or electric shock.
- Do not insert or drop metallic or inflammable foreign objects into the camera through access points e.g. CARD slot and battery chamber. This may cause a fire or electric shock.
- Do not operate this camera with wet hands. This could pose a risk of electric shock.



SAFETY NOTE



NOTE

- Do not leave this camera in places subject to extremely high temperatures, such as a sealed vehicle, direct sunlight or other places of extreme variances in temperature. Exposure to extreme temperatures may adversely affect the camera's internal components and could cause a fire.
- When in use, do not cover the camera or AC Power Adapter. This may cause heat to build up and distort the camera case or cause a fire.
- Always use the camera and its accessories in a well-ventilated area. Leakage, overheating, or burst batteries could result in fire or injury. Do not short circuit, heat or dispose of batteries in fire. Do not use old batteries with new ones, or mix brands of batteries. Ensure the batteries are positioned correctly with regard to polarity (+ / -).
- When the camera is not in use for long periods, always unplug the camera from its power source (batteries or AC Power Adapter) for safety purposes. Leaking batteries can cause fire and pollution to the environment.
- Allowing dust to accumulate in the camera over a long period is hazardous as extreme circumstances may cause a fire. It is best to clean your camera prior to seasonal periods of high humidity. Consult your dealer or Samsung Camera Service Center for information on the cost of cleaning your camera.
- Do not move the camera while it is switched on, if you are using the AC Power Adapter. After use, always switch off the camera before unplugging the adapter from the AC Power wall socket. Then make sure that any connector cords or cables to other devices are disconnected before moving the camera. Failure to do so may damage the cords or cables and cause a fire or electric shock.



IDENTIFICATION OF FEATURES

Product Exterior (Front / Top / Bottom)

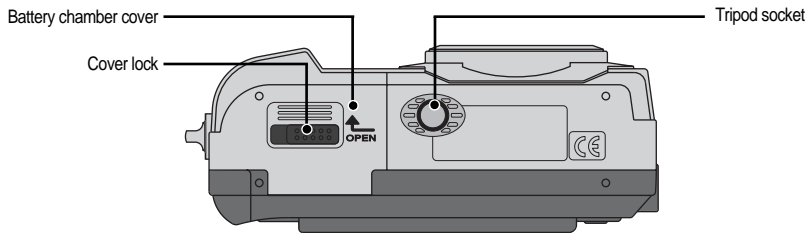
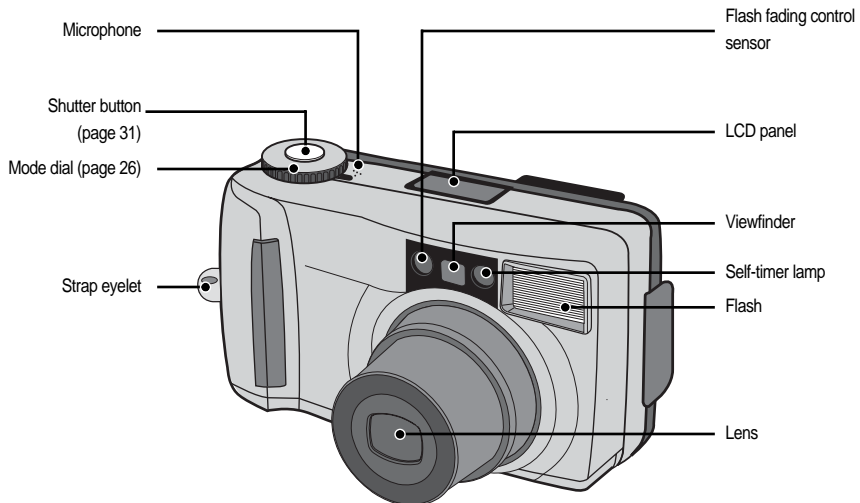

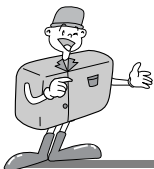

IDENTIFICATION OF FEATURES

READY

Product Exterior (Back)

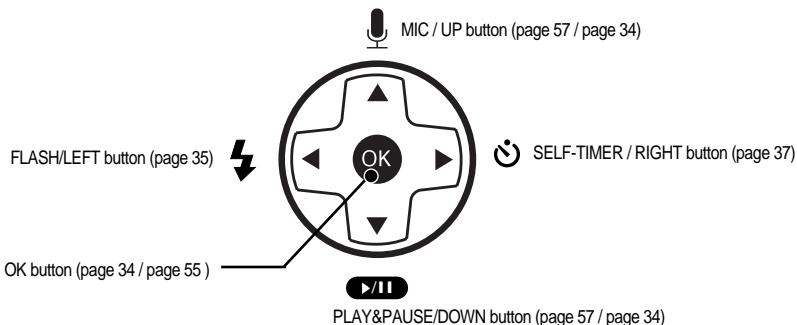
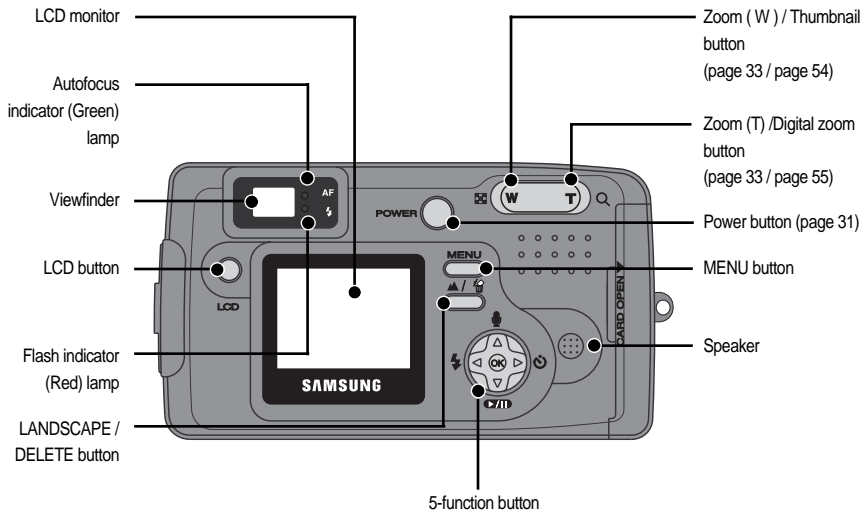



IDENTIFICATION OF FEATURES

Product Exterior (side)

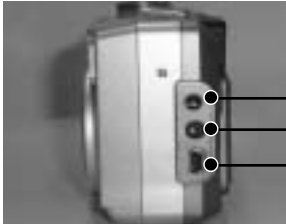

DC input connection point (DC 6V IN)

Video connection terminal

USB connection terminal

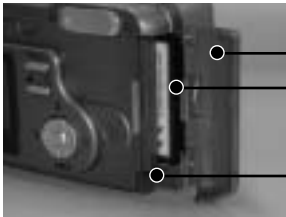

Card cover

CF CARD

Card eject lever

Viewfinder

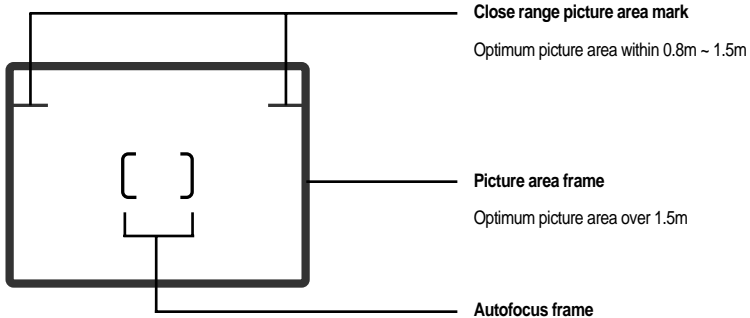



IDENTIFICATION OF FEATURES



Reference

- Vertical and Horizontal shots are taken in the same way.
- Avoid obstructing the lens or the flash when you take a picture.



[Horizontal grip]



[Vertical grip]



Note

- As there can be some differences between what is seen through the Viewfinder and the resulting image when taken at a range closer than 1.5m, it is recommended that you use the LCD monitor to compose the shot.

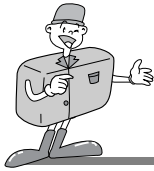

IDENTIFICATION OF FEATURES



LCD panel indicator

The LCD panel displays information about the shooting conditions.



Image size

· Digimax 410 · Digimax 340
L : 2272X1704 L : 2048X1536
M : 1600X1200 M : 1024X 768
S : 640X 480 S : 640X 480

Flash

Auto flash and Red eye reduction :  

Slow synchro : No indicator

Auto flash :  

Fill in flash : 

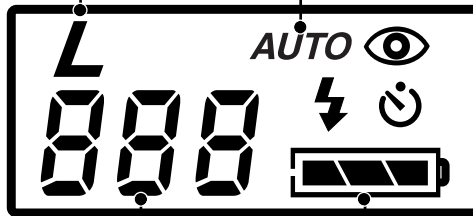

Flash off : 



Shooting information

MACRO SHOT mode : Number of available shots remaining
STILL IMAGE mode : Number of available shots remaining
MOVIE CLIP mode : Available recording time
PLAY mode : Number of available shots remaining
SETUP mode : Number of available shots remaining
PC mode : USB

Battery condition indicator

 : The batteries are fully charged
 : Prepare new batteries
 : There is no battery capacity
Replace new batteries



IDENTIFICATION OF FEATURES

LCD monitor indicator

The LCD monitor displays information about the shooting conditions.

■ SHOT mode

Whenever you press the LCD button, the LCD monitor will change in the following order :
Image & Status → Image only → LCD Off.

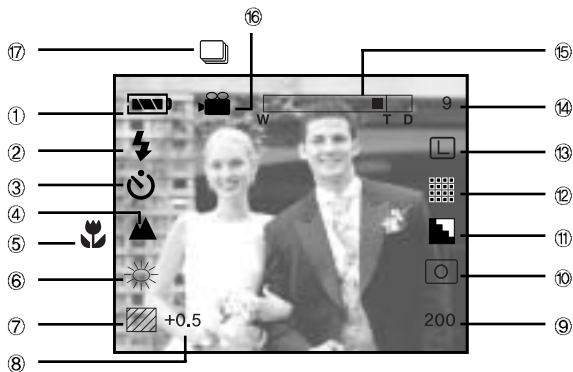

【 Image & Status 】

1	Battery condition		page 14
2	Flash		page 36
3	Self-timer		page 37
4	Landscape shot		page 32
5	Macro shot		page 26
6	White balance		page 44
7	Metering methods		page 48
8	Exposure compensation	-2.0 ~ 0 ~ +2.0	page 46



IDENTIFICATION OF FEATURES

9	ISO	AUTO 200 400	page 49
10	Focusing Methods		page 39
11	Sharpness		page 50
12	Image quality		page 43
13	Image size	L M S	page 42
14	Number of available shots remaining	9	
15	Zoom / Digital zoom		page 33
16	Movie clip shot		page 30
17	Shooting mode		page 40

■ PLAY mode

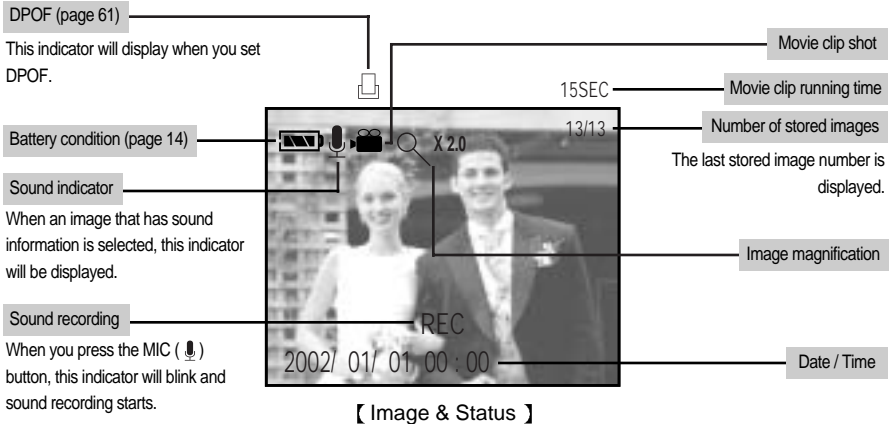

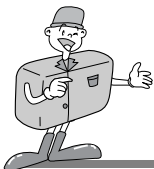

IDENTIFICATION OF FEATURES

LCD monitor menu indicator

■ Each mode has a menu as shown below. The default settings in each mode are printed below.

[STILL IMAGE / MACRO SHOT mode]

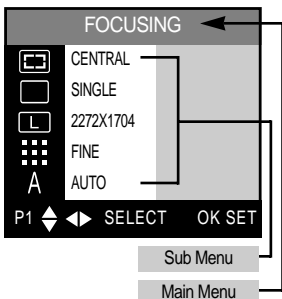

- FOCUSING : select focusing methods (page 39)
- SHOOTING MODE : select shooting mode (page 40)
- IMAGE SIZE : select image size (page 42)
Digimax 410 : 2272X1704
Digimax 340 : 2048X1536
- QUALITY : select image quality (page 43)
- WHITE BALANCE : select white balance (page 44)

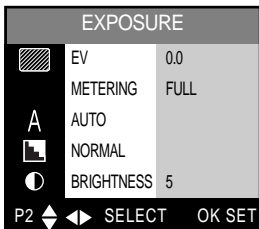

- EXPOSURE : select exposure value (page 46)
Select metering methods (page 48)
- ISO : select ISO sensitivity (page 49)
- SHARPNESS : select image sharpness (page 50)
- LCD : select LCD brightness (page 51)

[MOVIE CLIP mode]

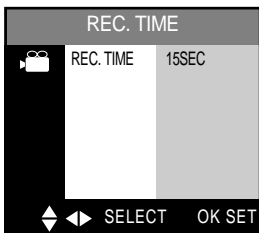

- REC.TIME : select recording time (page 52)



IDENTIFICATION OF FEATURES

【 PLAY mode 】



- DELETE ALL : delete all stored images (page 59)
- SLIDE SHOW : select slide show function (page 60)
- DPOF : select DPOF function (page 61)
- FOLDER : change the folder name to 100SSCAM (page 64)
- LCD : select LCD brightness (page 64)

【 SETUP mode 】

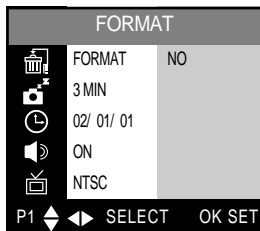

- FORMAT : format CF CARD (page 65)
- POWER OFF : select auto power off time (page 66)
- DATE/TIME : select date/time (page 67)
- BEEP : set the beep sound ON/OFF (page 68)
- VIDEO OUT : select video out signal (page 69)

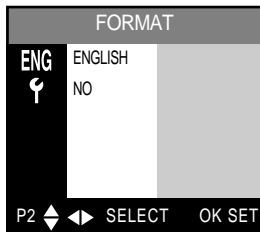

- LANGUAGE : select OSD(On Screen Display) language (page 70)
- RESET : select the default camera setting (page 71)



Reference

- There is no associated menu in PC mode and the LCD monitor is always turned off in PC mode.



PREPARATION

Connecting to Power

There are two ways in which to provide the camera with power. You can use batteries (AA Alkaline, Ni-MH), or alternatively, you can use an AC Adapter (DC 6V / 2.0A).

■ Using the batteries

1 Pull the battery chamber cover lock in the direction of the arrow(①) and open the battery chamber cover by pushing in the direction of the arrow(②).

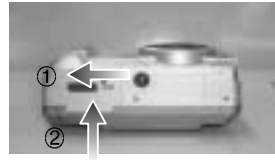

2 Insert the batteries taking note of the polarity (+ / -).



3 To close the battery chamber cover, push it until it clicks.

Reference

- This camera will automatically switch off when not in use for a period of time.
- We recommend high-capacity ALKALINE batteries (2000mAh) as manganese batteries cannot deliver sufficient power.

Note

▶ Important information about battery usage

- Please remove the batteries if the camera will not be used for long periods. Batteries can lose power over time and are prone to leaking if kept inside the camera.
- Low temperatures (below 0°C) can affect the performance of the batteries and you may experience reduced battery life.
- Batteries will normally recover at normal temperatures.
- Do not use old and new batteries at the same time.
- During extended use of the camera, the camera body may become warm. This is perfectly normal. If you are planning to use this camera for long periods of time, it is advisable to use an AC adapter.



PREPARATION

■ Using the AC power adapter

- If you have access to a mains supply, using an AC Adapter allows the camera to be used for long periods of time. If you connect the camera to a computer, it is advisable to use an AC adapter, as this will enable extended use.
- Plug the adapter into the connection point (DC IN 6V) on the camera. Please ensure that you use an AC adapter with the correct specification for the camera (6v /2.0A). Failure to do so may affect your warranty.



WARNING

- Always turn off the power before taking the AC adapter out of the mains supply.
- As with all mains powered devices, safety is important. Ensure that neither the camera nor adapter comes into contact with water or metallic materials.

Attaching the strap

- To prevent accidental damage to the camera, always use the strap.
- Refer to the illustrations below

1



2





PREPARATION

Inserting the CF CARD

- 1 Pull the card cover in the direction of the arrow to open.
- 2 Insert the card towards the arrow. The back side of the CF CARD and the LCD monitor should face in the same direction when the card is inserted.
- 3 To close the card cover, push the card cover against the arrow (step 1) until you hear a click.



Removing the CF CARD

- 1 Turn the power off using the power button (①).
- 2 Open the card cover and push the Card eject lever (②) down.
- 3 Remove CF CARD as shown in the picture.



※ CompactFlash™ card is the registered trademark of Sandisk.



Note

- . Repeated use of a CF CARD will eventually reduce the card's performance. Should this be the case, you will need to purchase a new CF CARD.

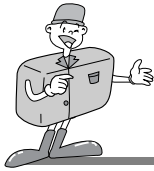

PREPARATION



Reference

- Using a 16/ 32MB CF CARD, the specified shooting capacity will be as follows.
(These figures are intended as an indication of expected performance)

Recorded image size	Recorded image quality	Number of shots			
		Digimax 340		Digimax 410	
		16MB	32MB	16MB	32MB
(Large) D-410 : 2272X1704 D-340 : 2048X1536	Super Fine	8	17	6	12
	Fine	12	25	12	25
	Normal	19	38	25	51
(Medium) D-410 : 1600X1200 D-340 : 1024X 768	Super Fine	19	38	12	25
	Fine	38	77	25	51
	Normal	77	155	51	103
(Small) D-410 : 640X480 D-340 : 640X480	Super Fine	77	155	77	155
	Fine	124	249	124	249
	Normal	182	366	182	366

- These figures are approximate as image capacities can be affected by variables such as card performance and subject matter.



PREPARATION

Instructions on how to use the CF CARD

■ Using a new CF CARD for the first time

- Before using the CF CARD, it must be initialized.
- Initializing prepares the CF CARD for recording data.
- For more details, please refer to page 65.

■ Preserving the CF CARD data

- If the card is subjected to any of the following, the recorded data may become corrupted :
 - When the CF CARD is used incorrectly.
 - If the power is switched off while recording, deleting, formatting) or reading.
- It is advisable to copy important data onto other media as back-up e.g. floppy disks, hard disks, CD etc.
- Samsung cannot be held responsible for lost data.

■ Important information on the use of the CF CARD

- If you switch off this camera while it is reading, initializing or playing, the information on the CF CARD may be corrupted.
- The CF CARD is an electronic precision device. Do not bend, drop or subject the card to any heavy impact.
- Do not store the CF CARD in an environment with strong electronic or magnetic fields, e.g. near loud speakers or TV receivers.
- Please do not use or store in an environment where there are extremes of temperature.
- Do not allow the CF CARD to become dirty or to come into contact with any liquid. Should this happen, clean the card with a soft cloth.
- Please keep the CF CARD in its case when not in use.
- During and after periods of extended use, you may notice that the CF CARD is warm. This is perfectly normal.



PREPARATION

Selecting the date and time

- You will need to check and select the correct Date / Time when : The camera is used for the first time. The batteries have been removed.
 - The DATE / TIME will only be displayed on the LCD monitor. When you print the image, the DATE /TIME will not be printed.
 - The DATE and TIME will be displayed on the lower end of the LCD monitor in PLAY mode.
 - The DATE and TIME will not be displayed in SHOT(STILL IMAGE/MACRO SHOT/MOVIE CLIP) mode.

1 Turn on the power by pressing the Power button.

2 Set the mode dial to the SETUP mode (**SET**).

3 The setup menu will be displayed on the LCD monitor.

4 Move to [DATE / TIME] menu by using the DOWN button (**▼**) on the 5-function button.

5 Move to [DATE / TIME] sub menu by using the RIGHT button (**▶**) on the 5-function button.

【 5-function button 】

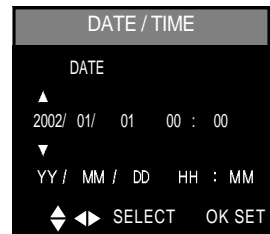

■ Selecting DATE

In step 5, select [DATE] by pressing UP(**▲**) / DOWN(**▼**) button and press OK button.

■ Selecting TIME

In step 5, select [TIME] by pressing UP(**▲**) / DOWN(**▼**) button and press OK button.



PREPARATION

- 6 To select YEAR/ MONTH / DAY or HOUR / MINUTE, press LEFT (◀) / RIGHT (▶) button.
To change the numbers, press UP (▲) / DOWN (▼) button.
- 7 Press the OK button to confirm the setting at the [DAY] or [MINUTE] sub menu.
The camera can now be used with the selected camera mode.



Reference

- . The selection range for date/time setup covers from 2002~2100.
(It is automatically programmed to allow for a leap year/ month)
- . It is originally set as [2002/01/01 00:00]



CAMERA WORKING MODE

Camera working mode

- You can select the desired working mode by using the mode dial located on the top of the camera.

This digital camera has 6 working modes. These are listed below.

- ▶ STILL IMAGE mode ()

This mode is used for taking still images from 0.8 ~ infinity and taking a moving subject continuously.

- ▶ MACRO SHOT mode ()

This mode is used for macro shots between 0.2m ~ 0.8m and taking a moving subject continuously. The flash mode is changed to FLASH OFF when this mode is selected, but you can change the flash mode.

- ▶ MOVIE CLIP mode ()

This mode is used for movie clips.

The flash is changed to FLASH OFF when this mode is selected.

- ▶ PLAY mode ()

In this mode, the stored images on the CF CARD can be viewed on the LCD monitor on the back of the camera or on an external monitor using a video output terminal. If you view an image which has additional sound recording, the sound will play back whilst the image is viewed. You can use single image play back, 6 thumbnail screen, slide show, one image deletion, all image deletion, sound recording and digital zoom in this mode.

- ▶ PC mode ()

Your computer will recognize the camera as a Removable Disk when connected by the USB cable. You can transfer images between the computer and the camera.

- ▶ SETUP mode (**SET**)

In this mode, you can set up basic settings such as format, auto power off, date / time, beep sound, video out and language.

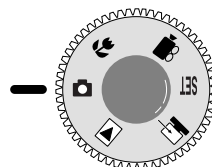

[Mode dial information]



TAKING PHOTOS

Now let's take a picture

- 1 To switch on the camera, press the POWER button (①).

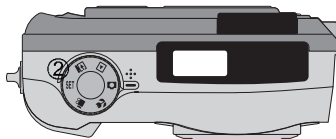
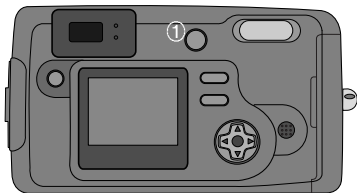

- 2 Select the desired shot mode (STILL IMAGE / MACRO SHOT / MOVIE CLIP) according to the image range or subject by using the mode dial (②) on the top of the camera.
- 3 Change the camera functions by using the LCD monitor and select the appropriate settings (image quality, image size etc.).
Refer to pages 30~73 for information on camera setting.
- 4 Decide the image composition that you want to achieve by using the optical viewfinder or the LCD monitor.
- 5 When taking images, squeeze the shutter button gently to avoid camera shake.
 - Pressing the shutter button down halfway activates the autofocus and checks the condition of the flash.
 - Pressing the shutter button down halfway activates the autofocus. After selecting the focus, the Green lamp will light up.
To prevent camera shake, press the Shutter button gently as the autofocus might be changed by camera shake.
When the green lamp illuminate, you can take a picture and store the relevant data for shot.



TAKING PHOTOS



Note

- Select MACRO SHOT mode when the subject is between 0.2m ~ 0.8m from the camera. Refer to page 26 for information on MACRO SHOT.
- If you do not select the correct shot mode appropriate to the distance from the subject to the camera, you will not be able to obtain a clear shot of the subject.
- Avoid obstructing the Flash control sensor when you take an image. An image can be spoiled when a finger, hair or camera strap is in front of the Flash control sensor.
- Using the LCD monitor extensively will drain the batteries. We recommend using the optical viewfinder as often as possible in order to extend battery life.
- If you take an image in a dark place a "LOW LUMINANCE" message will display on the LCD monitor. In addition, it may cause the camera to fix the focus as listed below.
Normal shot mode : 2.0M Macro shot mode : 0.5M
In this case, increase the lighting value or take an image in a bright place.



Reference

- If there is no card, [NO CARD] message will show in the LCD monitor.
- If there is insufficient memory available, the following message is displayed and the camera will not operate.

CARD FULL

- To optimize the amount of memory in the camera, replace the CF CARD or delete unnecessary images stored on the CF CARD.



TAKING PHOTOS



Reference

There are two LED lamps (one green, one red) positioned next to the viewfinder.



- If the camera is in focus when you press the shutter button halfway, the green LED will light up and you can take an image.
- If the red lamp lights up, the flash can fire.
- If the red lamp blinks, the flash is being charged.
- When an image is being stored onto the CF CARD, the green lamp blinks slowly. When the image data has been stored, the green LED light will go out. After the green LED light has gone out, you can resume taking images.



Note

Under certain conditions the auto focus system may not perform as expected.

- When photographing a subject that has little contrast.
- If the subject is highly reflective or shiny.
- If the subject is moving at high speed.
- When the subject matter has only horizontal lines or the subject is very narrow (such as a stick or flagpole).
- When there is strong reflected light, or when the background is very bright.

Backlight compensated shot

- When taking an outdoor shot, avoid facing the sun, as the image may be dark because of backlight. In backlight conditions, please use the exposure compensation (refer to page 46). Alternatively, use SPOT metering function (refer to page 48) and the exposure will be adjusted accordingly.



SETTING UP THE SHOOTING FUNCTION

Movie clip shot

- When the mode dial is rotated to MOVIE CLIP mode, the LCD monitor will be displayed as shown below.

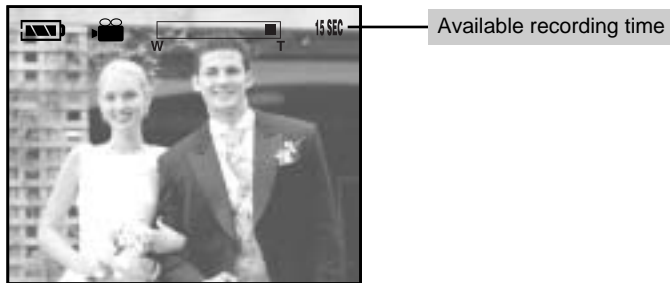

- Press the shutter button once and movie clips are recorded for as long as the available recording time allows. Movie clips will still be recorded if the shutter button is released.
- If you wish to stop recording, press the shutter button again.
- The self-timer lamp (red) on the front of the camera will illuminate during the recording.
- Image size and type are listed below.
 - Image size : QVGA (320 x 240)
 - File type : *.AVI
- When the movie clip is being recorded to the CF CARD, the Green lamp blinks. [RECORDING] message will be displayed on the LCD monitor.



Note

- Due to the CF CARD capacity the recording may be suspended during the available recording time.



SETTING UP THE SHOOTING FUNCTION

Using the camera button to adjust the camera

- Shot mode(STILL IMAGE / MACRO SHOT / MOVIE CLIP) functions can be set up using the camera button.

POWER button

- Used for turning the camera power on / off.
- The camera power will be turned off automatically during periods of inactivity.
The camera can be reactivated by pressing the power button again.

SHUTTER button

- Used for taking images in shot mode (STILL IMAGE / MACRO SHOT / MOVIE CLIP).
- Pressing the shutter button down halfway activates the autofocus and checks the condition of the flash. Pressing the shutter down fully takes the image and stores the relevant data regarding the shot.



SETTING UP THE SHOOTING FUNCTION

LCD button

- Pressing the LCD button in the shot (STILL IMAGE / MACRO SHOT / MOVIE CLIP)mode will change the display as shown below.



MENU button

- When you press the MENU button, a menu related to each camera mode will be displayed on the LCD monitor. Pressing it again will return the LCD to the initial display.
 - A menu option can be displayed when the following are selected : shot(STILL IMAGE / MACRO SHOT / MOVIE CLIP)mode, PLAY mode and SETUP mode.
- There is no menu available when PC mode is selected.

LANDSCAPE button

- Used for taking landscape scenes.



Note

- After taking the landscape scene, the focus will be adjusted for landscape scene. If you want to take a normal scene, press the LANDSCAPE button to change the focus mode.



SETTING UP THE SHOOTING FUNCTION

ZOOM (W/T) button

- Used for digital or optical zooming in / out in SHOT mode (STILL IMAGE / MACRO SHOT / MOVIE CLIP).
- Digital zooming is not available in MOVIE CLIP mode
- When you press the zoom (W/T) button, the zoom bar will display in the upper centre of the LCD monitor.

■ Optical zoom

1. Zoom TELE

Press zoom button T.

This will zoom into the subject i.e. the subject will appear nearer.

2. Zoom WIDE

Press zoom button W.

This will zoom out from the subject i.e. the subject will appear further away. Pressing the W button continuously will set the camera to its minimum zoom setting i.e. the subject appears at its furthest from the camera.

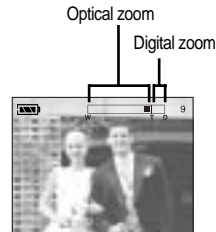

■ Digital zoom

- To use digital zoom, the LCD monitor has to be turned on.
- The digital zoom will operate only when the optical zoom is at its maximum i.e. when the subject appears to be at its closest. Pressing the T button again will operate the digital zoom.

■ Cancel Digital zoom

- Pressing the W button will reduce the digital zoom and pressing the W button again will proceed to reduce the optical zoom until the minimum setting is reached or the button is released.



SETTING UP THE SHOOTING FUNCTION



Reference

- Images taken using the digital zoom may take a little longer for the camera to process. Allow time for this to take place.
- The digital zoom cannot be used in movie clip shots.
- You may notice a decrease in image quality when using digital zoom.



Note

- Take care not to touch the lens during the zoom operation as this may cause damage. Take care not to touch the lens to avoid taking a dim image and camera malfunction.
- When the camera is turned on, take care not to touch the camera's moving parts of lens as this may make the image dim.
- Take care not to touch the lens during the zoom operation as this may make the image dim. If the image is dim, turn the camera power off and turn on again to modify the lens position.

OK button

- Used as a confirming data that is changed by using ▲ / ▼ / ◀ / ▶ buttons.

UP button

- When the menu is displayed on the LCD monitor, pressing the UP (▲) button makes the cursor shift to up, or changes the sub menu.

DOWN button

- When the menu is displayed on the LCD monitor, pressing the DOWN (▼) button makes the cursor shift to down or changes the sub menu.

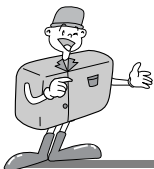

SETTING UP THE SHOOTING FUNCTION

FLASH / LEFT button

- When the menu is displayed on the LCD monitor, pressing the LEFT (◀) button makes the cursor shift to the left or to the main menu.
- When the menu is not displayed on the LCD monitor, the LEFT (◀) button operates as the FLASH (⚡) button.
- Use the correct flash to suit the environment.

1. Turn the camera power on.
2. Rotate the mode dial to the STILL IMAGE mode or MACRO SHOT mode.
3. Do not turn the LCD monitor off.
4. Press the FLASH (⚡) button until the desired FLASH mode indicator displays on the LCD monitor.
5. Take a picture.



< Selecting Auto flash >

ADVANCED



Note

- Photograph within the flash range. The flash ranges are listed below.

	ISO	W	T
MACRO SHOT mode	A	0.5 ~ 0.8m	
STILL IMAGE mode	A	0.8 ~ 3m	0.8 ~ 2m

- The image quality is not guaranteed if the subject is too close or highly reflective.



SETTING UP THE SHOOTING FUNCTION

■ Flash mode indicator

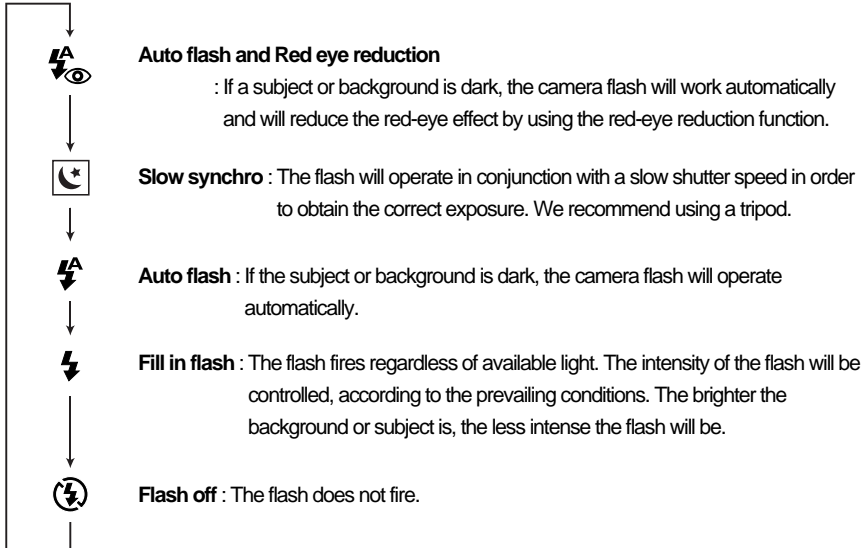

Reference

- Using the flash frequently will reduce the life of the batteries.
- Under normal operating conditions the charging time for the flash is normally within 7 seconds. If the batteries are weak, the charging time will be longer.
- The default of each mode is listed below.
 - STILL IMAGE mode : Auto flash and Red eye reduction
 - MACRO SHOT mode : Flash off (user selectable)
 - MOVIE CLIP mode : Flash off (fixed)



SETTING UP THE SHOOTING FUNCTION

SELF-TIMER / RIGHT button

- When the menu is displayed on the LCD monitor, pressing the RIGHT (►) button makes the cursor shift to the sub menu.
- When the menu is not displayed on the LCD monitor, the RIGHT (►) button operates as the SELF-TIMER (⏱) button.
- This function is used when the photographer would also like to be in the image.

1. Turn the camera power on.
2. Rotate the mode dial to the shot mode (STILL IMAGE / MACRO SHOT).
3. Do not turn the LCD monitor off.
4. If the self-timer indicator is displayed on the LCD monitor and LCD panel by pressing the SELF TIMER (⏱) button, the setting is completed.
5. Pressing the shutter button will allow an interval of 10 seconds before the image is taken. After that, the self-timer is cancelled.



< Selecting Self-timer >



Reference

- The default is OFF
- The self-timer LED lamp (red) and Self timer indicator on the LCD monitor will blink for 10 seconds after the SELF-TIMER button has been pressed.
 - For the first seven seconds, the LED blinks at one second intervals.
 - For the final three seconds, the LED blinks quickly at 0.5-second intervals.



SETTING UP THE SHOOTING FUNCTION

Using the LCD monitor to adjust the camera

- Shooting functions can be changed by using the LCD monitor.
- In the shot mode, pressing the MENU button displays the menu on the LCD monitor.
- The following functions are available, depending on the mode you have selected (STILL IMAGE / MACRO SHOT / MOVIE CLIP).

	STILL IMAGE mode	MACRO SHOT mode	MOVIE CLIP mode
FOCUSING	○	○	X
SHOOTING MODE	○	○	X
IMAGE SIZE	○	○	X
QUALITY	○	○	X
WHITE BALANCE	○	○	X
EXPOSURE	○	○	X
ISO	○	○	X
SHARPNESS	○	○	X
LCD	○	○	X
REC.TIME	X	X	○



Reference

- ▶ The menu will not be displayed on the LCD monitor under the following conditions :
 - When another button is being operated.
 - While image data is being processed. (when the green LED next to the viewfinder flashes)
 - When there is no battery capacity.

- ▶ Explanation of the 5-function button .



- UP button (▲) : Pressing the UP button (▲) makes the cursor move up.
- DOWN button (▼) : Pressing the DOWN button (▼) makes the cursor move down.
- LEFT button (◀) : Pressing the LEFT button (◀) makes the cursor move to the left.
- RIGHT button (▶) : Pressing the RIGHT button (▶) makes the cursor move to the right
- OK button : Pressing the OK button confirms the selection.
- ▶ When the menu is showing on the LCD monitor, it is not possible to operate the shutter button i.e. take an image. To take an image, simply cancel the menu display by pressing the MENU button. The menu will no longer show and the camera is ready to take an image.



SETTING UP THE SHOOTING FUNCTION

FOCUSING

- In STILL IMAGE and MACRO SHOT mode, you can select the focusing range.

1. Turn the camera power on.
2. Rotate the mode dial to the STILL IMAGE mode or MACRO SHOT mode.
3. Do not turn the LCD monitor off.
4. Press MENU button to display the menu on the LCD monitor.
5. Press UP (▲) / DOWN (▼) button and select [FOCUSING].
6. The cursor can be moved by pressing the RIGHT (▶) button to the [FOCUSING] sub menu.
7. Select the desired sub menu by pressing the UP (▲) / DOWN (▼) buttons. The default is CENTRAL.
8. After selecting the desired sub menu, press the OK button to confirm the setting.
9. Press the MENU button to cancel the menu display.

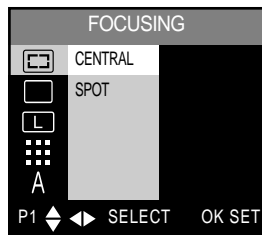

< STILL IMAGE mode >

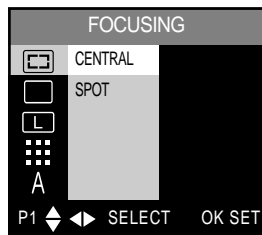

< MACRO SHOT mode >



SETTING UP THE SHOOTING FUNCTION

SHOOTING MODE

- This allows continuous shooting.
- In this mode, you can take moving subjects continuously.
- Once a continuous shooting sequence has been completed, the camera resets to single shooting mode.

1. Turn the camera power on.
2. Rotate the mode dial to the STILL IMAGE mode or MACRO SHOT mode.
3. Do not turn the LCD monitor off.
4. Press MENU button to display the menu on the LCD monitor.
5. Press UP (▲) / DOWN (▼) button and select [SHOOTING MODE].
6. The cursor can be moved by pressing the RIGHT (►) button to the [SHOOTING MODE] sub menu.
7. Select the desired sub menu by pressing the UP (▲) / DOWN (▼) buttons. The default is SINGLE
8. After selecting the desired sub menu, press the OK button to confirm the setting.
9. Press the MENU button to cancel the menu display.

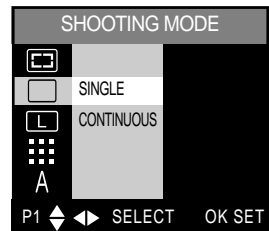

< STILL IMAGE mode >

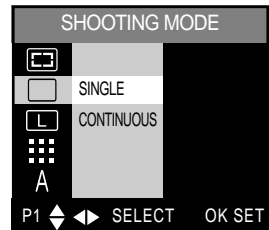

< MACRO SHOT mode >



SETTING UP THE SHOOTING FUNCTION



Reference

- When [CONTINUOUS] is selected, the flash will automatically be cancelled.
- To stop the CONTINUOUS shooting, release the shutter button.



SETTING UP THE SHOOTING FUNCTION

SIZE

- In STILL IMAGE and MACRO SHOT mode, you can select the image size.
- A large image uses more memory, so increasing image size will reduce the total number of shots you can store on a CF CARD. The image sizes are listed below.

Digimax 410 **L** 2272x1704 **M** 1600x1200 **S** 640x480

Digimax 340 **L** 2048x1536 **M** 1024x768 **S** 640x480

1. Turn the camera power on.
2. Rotate the mode dial to the STILL IMAGE mode or MACRO SHOT mode.
3. Do not turn the LCD monitor off.
4. Press MENU button to display the menu on the LCD monitor.
5. Press UP (▲) / DOWN (▼) button and select [IMAGE SIZE].
6. The cursor can be moved by pressing the RIGHT (►) button to the [IMAGE SIZE] sub menu.
7. Select the desired sub menu by pressing the UP (▲) / DOWN (▼) buttons.
The default is Digimax 410 : 2272x1704
Digimax 340 : 2048x1536.
8. After selecting the desired sub menu, press the OK button to confirm the setting.
9. Press the MENU button to cancel the menu display.

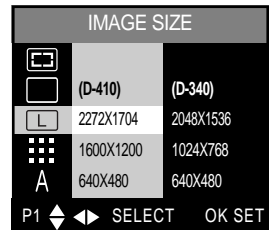

< STILL IMAGE mode >

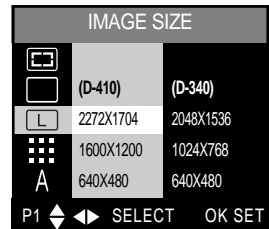

< MACRO SHOT mode >



SETTING UP THE SHOOTING FUNCTION

QUALITY

- In STILL IMAGE and MACRO SHOT mode, you can select the image data compression rate.
- The higher the QUALITY setting, the better the final image will be. However, the high quality setting will require more memory and therefore reduce the number of images you can store on the CF CARD.
- SUPER FINE is the highest quality and NORMAL is the lowest setting. Choose the setting appropriate for your needs.

1. Turn the camera power on.
2. Rotate the mode dial to the STILL IMAGE mode or MACRO SHOT mode.
3. Do not turn the LCD monitor off.
4. Press MENU button to display the menu on the LCD monitor.
5. Press UP (▲) / DOWN (▼) button and select [QUALITY].
6. The cursor can be moved by pressing the RIGHT (►) button to the [QUALITY] sub menu.
7. Select the desired sub menu by pressing the UP (▲) / DOWN (▼) buttons. The default is SUPER FINE.
8. After selecting the desired sub menu, press the OK button to confirm the setting.
9. Press the MENU button to cancel the menu display.

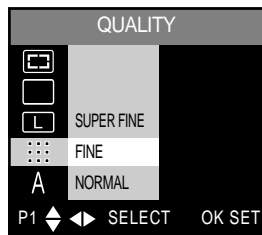

< STILL IMAGE mode >

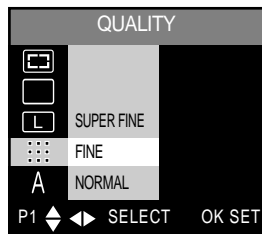

< MACRO SHOT mode >

ADVANCED



Reference

- The image file is stored in *.jpg.
- This file format complies with DCF(Design rule for Camera File system).



SETTING UP THE SHOOTING FUNCTION

WHITE BALANCE

- Different lighting conditions may cause a color cast on your images.
- The white balance control allows you to adjust the colors to appear more natural looking.
- The setting remains until the power is turned off.

1. Turn the camera power on.
2. Rotate the mode dial to the STILL IMAGE mode or MACRO SHOT mode.
3. Do not turn the LCD monitor off.
4. Press MENU button to display the menu on the LCD monitor. Press UP (▲) / DOWN(▼) button and select [WHITE BALANCE].
5. The cursor can be moved by pressing the RIGHT (▶) button to the [WHITE BALANCE] sub menu.
6. Select the desired sub menu by pressing the UP (▲) / DOWN (▼) buttons. The default is AUTO.
7. After selecting the desired sub menu, press the OK button to confirm the setting.
8. Press the MENU button to cancel the menu display.

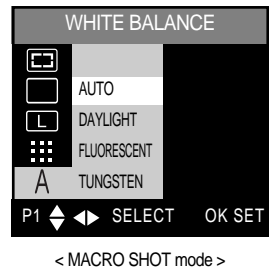
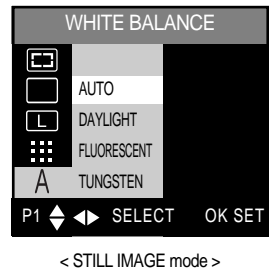



SETTING UP THE SHOOTING FUNCTION



Reference

W.BALANCE sub menu explained

- AUTO : The camera automatically selects the appropriate white balance settings, depending on the prevailing lighting conditions.
- DAYLIGHT : For taking images outside.
- FLUORESCENT : For shooting under fluorescent lighting.
- TUNGSTEN : For shooting under tungsten (standard light bulb) and halogen lighting.

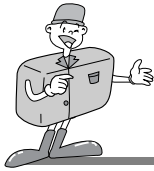

SETTING UP THE SHOOTING FUNCTION

EXPOSURE

- This camera automatically adjusts the exposure according to the ambient lighting conditions. However, you can select the exposure value by using [EXPOSURE] sub menu.
- This function can be used in STILL IMAGE and MACRO SHOT mode.
- If you increase the exposure value, the image will be brighter.
- If you decrease the exposure value, the image will be darker.

1. Turn the camera power on.
2. Rotate the mode dial to the STILL IMAGE mode or MACRO SHOT mode.
3. Do not turn the LCD monitor off.
4. Press MENU button to display the menu on the LCD monitor. Press UP (▲) / DOWN (▼) button and select [EXPOSURE].
5. To select [EV], press the RIGHT (►) button
6. The cursor can be moved by pressing the RIGHT (►) button to the [EV] sub menu.

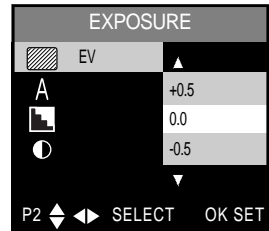

< STILL IMAGE mode >

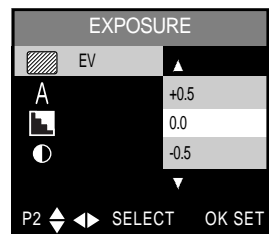

< MACRO SHOT mode >



SETTING UP THE SHOOTING FUNCTION

7 Select the desired sub menu by pressing the UP (▲) / DOWN (▼) buttons.

The default setting is 0.0 EV. The camera calculates the exposure value automatically.

8. After selecting the desired sub menu, press the OK button to confirm the setting.

9. Press the MENU button to cancel the menu display.



Reference

- Exposure compensation setting range : -2.0 ~ +2.0 EV (0.5 EV steps)
- This change to the exposure will remain until the camera is switched off.
When the camera is turned on again, the exposure compensation setting returns to 0.0EV (discarding the exposure compensation).
- When you have selected a change in exposure value, the value is displayed on the LCD.
- Decreasing or increasing the exposure value may lead to images being under or over exposed (too dark or too bright).
Review your images using the LCD monitor to check that they have been successful.



SETTING UP THE SHOOTING FUNCTION

METERING

- This button can be used to obtain the right exposure.

1. Turn the camera power on.
2. Rotate the mode dial to the STILL IMAGE mode or MACRO SHOT mode.
3. Do not turn the LCD monitor off.
4. Press MENU button to display the menu on the LCD monitor. Press UP (▲) / DOWN (▼) button and select [EXPOSURE].
5. The cursor can be moved by pressing the RIGHT (►) button to the [EV] sub menu.
6. Press UP (▲) / DOWN (▼) button and select [METERING].
7. The cursor can be moved by pressing the RIGHT (►) button to the [METERING] sub menu.
8. Select the desired sub menu by pressing the UP (▲) / DOWN (▼) buttons. After selecting the desired sub menu, press the OK button to confirm the setting. The default is FULL.
9. Press the MENU button to cancel the menu display.

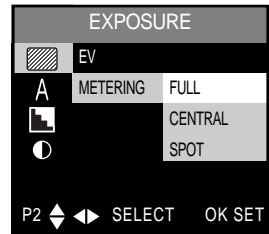

< STILL IMAGE mode >

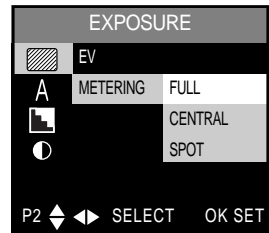

< MACRO SHOT mode >

■ METERING mode indicator

- FULL : Exposure will be calculated based on an average of the light available in the whole image area.
- CENTER : Exposure will be calculated based on an average of the light available in the image area. However, the calculation will be biased towards the centre of the image area.
- SPOT : Use this function when there is backlight or when photographing a subject that has little contrast.
In backlighting conditions adjust the light metering to suit the subject matter.



SETTING UP THE SHOOTING FUNCTION

ISO

- You can select the camera's sensitivity to light by selecting the ISO sub menu.
- Raising the ISO sensitivity will mean that the camera needs less light in order to take an image. However, the higher the ISO value is, the grainier the image will be.
 - AUTO : The camera's sensitivity is automatically changed by variables such as lighting value or subject brightness.
 - 200/400 : In the same lighting condition, the higher ISO value is, the faster the shutter speed will be. However, the images can be saturated with the high brightness condition.

1. Turn the camera power on.
2. Rotate the mode dial to the STILL IMAGE mode or MACRO SHOT mode.
3. Do not turn the LCD monitor off.
4. Press MENU button to display the menu on the LCD monitor. Press UP (▲) / DOWN (▼) button and select [ISO].
5. The cursor can be moved by pressing the RIGHT (►) button to the [ISO] sub menu.
6. Select the desired sub menu by pressing the UP (▲) / DOWN (▼) buttons. The default is AUTO.
7. After selecting the desired sub menu, press the OK button to confirm the setting.
8. Press the MENU button to cancel the menu display.

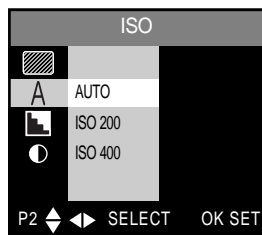

< STILL IMAGE mode >

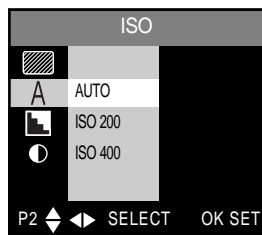

< MACRO SHOT mode >



SETTING UP THE SHOOTING FUNCTION

SHARPNESS

- In STILL IMAGE and MACRO SHOT mode, you can select the image sharpness.
- Select the desired SHARPNESS (SOFT/ NORMAL/ HARD) depending on the subject matter.

1. Turn the camera power on.
2. Rotate the mode dial to the STILL IMAGE mode or MACRO SHOT mode.
3. Do not turn the LCD monitor off.
4. Press MENU button to display the menu on the LCD monitor.
5. Press UP (▲) / DOWN (▼) button and select [SHARPNESS].
6. The cursor can be moved by pressing the RIGHT (▶) button to the [SHARPNESS] sub menu.
7. Select the desired sub menu by pressing the UP (▲) / DOWN (▼) buttons. The default is NORMAL.
8. After selecting the desired sub menu, press the OK button to confirm the setting.
9. Press the MENU button to cancel the menu display.

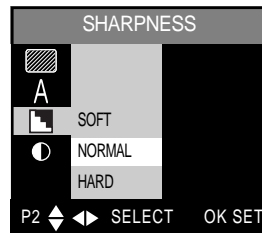

< STILL IMAGE mode >

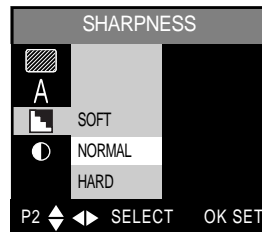

< MACRO SHOT mode >



Reference

Explanation of SHARPNESS sub menu

- SOFT : This gives smooth edges and the final image will have a soft appearance.
- NORMAL : This setting will give a standard finish to the final image.
- HARD : This will give the image a crisp and clear appearance.



SETTING UP THE SHOOTING FUNCTION

LCD

- You may adjust the LCD brightness.

1. Turn the camera power on.
2. Rotate the mode dial to the STILL IMAGE mode or MACRO SHOT mode.
3. Do not turn the LCD monitor off.
4. Press MENU button to display the menu on the LCD monitor. Press UP (▲) / DOWN (▼) button and select [LCD].
5. The cursor can be moved by pressing the RIGHT (▶) button to the [BRIGHTNESS] sub menu.
6. LCD BRIGHTNESS SELECTION SCREEN as shown alongside will be displayed by pressing the RIGHT (▶) button.
7. Select the desired brightness value by pressing the UP (▲) / DOWN (▼) buttons.
The LCD monitor has 9 brightness settings.
8. After selecting the desired brightness value, press the OK button to confirm the setting.
9. Press the MENU button to cancel the menu display.

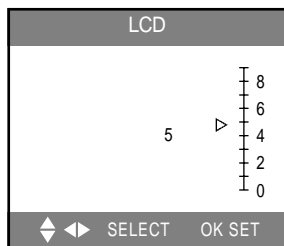
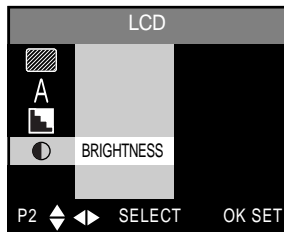



SETTING UP THE SHOOTING FUNCTION

REC. TIME

- You can select available recording time.
- This menu can be used in MOVIE CLIP mode.

1. Turn the camera power on.
2. Rotate the mode dial to the MOVIE CLIP mode.
3. Do not turn the LCD monitor off.
4. Press MENU button to display the menu on the LCD monitor.
Press UP (▲) / DOWN (▼) button and select [REC.TIME].
5. Press RIGHT (►) button and [REC.TIME] will be displayed.
6. The cursor can be moved by pressing the RIGHT (►) button to the [REC.TIME] sub menu.
7. Select the desired sub menu by pressing the UP (▲) / DOWN (▼) buttons. The default is 15SEC.
8. After selecting the desired sub menu, press the OK button to confirm the setting.
9. Press the MENU button to cancel the menu display.



< MOVIE CLIP mode >

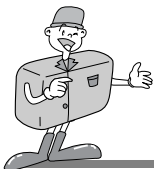

SETTING UP PLAY BACK FUNCTIONS

Starting PLAY Mode

- Turn the camera on and select PLAY mode (▶▶) on the mode dial. The camera can now play back the images stored on the CF CARD. Sound can also be added to images in this mode.
- You can setup the PLAY mode function by using the camera buttons and LCD monitor.
- PLAY mode functions are listed below.

Camera button		THUMBNAIL, ZOOM DELETE VOICE RECORDING PLAY & PAUSE
LCD monitor	Play back	SLIDE SHOW, LCD brightness DELETE ALL, FOLDER
	Print setting	QUANTITY, INDEX CANCEL

ADVANCED



Reference

- The last image stored on the CF CARD will be displayed on the LCD monitor.
- The LCD monitor will remain in operation until the camera is switched off.

The menu will not display on the LCD monitor under the following circumstances :

- When another button is being pressed.
- While image data is being processed.
- When there is no battery capacity.



SETTING UP PLAY BACK FUNCTIONS

Setting up play back function by using the camera button

- The PLAY mode can be set using the camera button.





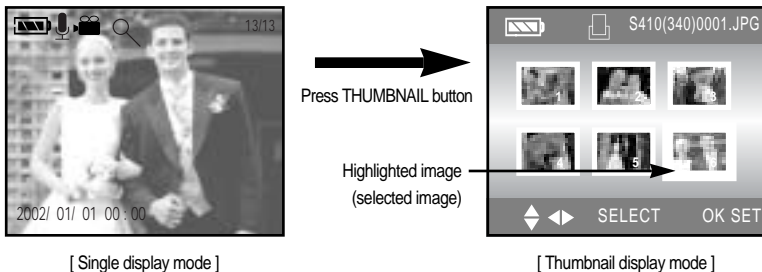

THUMBNAIL / ZOOM W button

- You can view up to 6 images at a time by using the THUMBNAIL function.

1. Turn the camera power on.
2. Rotate the mode dial to the PLAY mode.
3. An image displays on the LCD monitor.
4. Press the THUMBNAIL () button.

The thumbnail display will highlight the image that had been showing at the time the thumbnail mode was selected.



5. Press the  /  /  /  buttons to move to the desired image. Selected image is highlighted. Icons are displayed to indicate the type of file selected.
6. When viewing a thumbnail image, press the [ZOOM T] button and the selected shot will show in single display mode.
 -  : Movie clip file
 -  : DPOF indicator
 -  : Sound recorded file



SETTING UP PLAY BACK FUNCTIONS

ZOOM T button

- When viewing a single image in PLAY mode, use the zoom T button to enlarge the selected image.
1. Turn the camera on.
 2. Rotate the mode dial to the PLAY mode ().
 3. Select the desired image.
 4. Enlarge the image to 2X scale of enlargement by using the ZOOM T button.
 5. Different parts of the image can be viewed by pressing the ▲ / ▼ / ◀ / ▶ buttons.
 6. Pressing the ZOOM W button will zoom back to the original full sized image.



< 2X scale of enlargement >

ADVANCED



Reference

- If an image is enlarged, the ratio indicator will display on the left upper side of the LCD monitor.
- Movie clips cannot be enlarged.
- If an image is enlarged, a loss of quality may occur.

MENU button

- Pressing the MENU button will display the PLAY mode menu. Pressing the MENU button again will cancel the menu display.
- A menu option can be displayed when the following are selected : shot (STILL IMAGE / MACRO SHOT / MOVIE CLIP)mode, PLAY mode and SETUP mode.
There is no menu available when PC mode is selected.

OK button

- When the LCD monitor is turned on, pressing this button allows the changed sub menu to confirm.



SETTING UP PLAY BACK FUNCTIONS

DELETE button

- This deletes images stored on the CF CARD.
1. Turn the camera power on.
 2. Rotate the mode dial to the PLAY mode.
 3. Press the LEFT (◀) / RIGHT (▶) buttons to select the image that you wish to delete.
 4. When you press the DELETE (🗑) button, a message will be displayed on the LCD monitor.



5. Select YES or NO by pressing UP (▲) / DOWN (▼) button.
 - Selecting NO : Press OK button.
 - The image will be displayed on the LCD monitor.
 - Selecting YES : Press OK button.
 - Once an image has been deleted, the next image in the sequence will appear on the LCD display.



SETTING UP PLAY BACK FUNCTIONS

MIC / UP button

- When the LCD monitor is turned on, pressing the UP (▲) button will either cause the cursor to move up or change a selected sub menu.
- When the LCD monitor is not turned on, pressing the UP (▲) button will allow a sound recording to be added to a stored still image.

1. Turn the camera on.
2. Rotate the mode dial to PLAY mode.
3. Press the LEFT (◀) / RIGHT (▶) buttons to select the image that you wish to add sound to.
4. Press MIC (🎤) button and the sound recording indicator will display. The sound is being recorded.
5. Recording can be stopped by pressing the MIC (🎤) button again. The sound will record for 10 seconds.



[Being recorded]

PLAY & PAUSE / DOWN button

- When the LCD monitor is turned on, pressing the DOWN (▼) button will move the cursor down or change the sub menu.
- When the LCD monitor is not turned on, the DOWN (▼) button is used as the PLAY & PAUSE (▶/||) button.
- The PLAY & PAUSE (▶/||) button is used for playing and pausing a sound recorded still image, movie clip or slide show.

1. Turn the camera power on.
2. Rotate the mode dial to PLAY mode.
3. Press the LEFT (◀) / RIGHT (▶) buttons to select a sound recorded still image or a movie clip. Or, select slide show.
4. Press PLAY & PAUSE (▶/||) button.



SETTING UP PLAY BACK FUNCTIONS

PLAY & PAUSE explained

- If an image is showing, but there is no sound (or movement) :
Press the PLAY & PAUSE (▶||) button to play the sound clip or to start the movie clip.



[A sound recorded still image]



[A movie clip]

- If the image is playing : The progress is paused.



[A sound recorded still image]



[A movie clip]



[Slide show]

- If the PLAY & PAUSE (▶||) button is pressed when the image is paused, the sound or movement will resume.



Reference

- When an image is being played back, press the MENU button to cancel the progress.



SETTING UP PLAY BACK FUNCTIONS

Setting up play back function using the LCD monitor

DELETE ALL

- This enables you to clear all images from the CF CARD.

Remember that this will permanently delete images. Important shots should be stored on a computer before deletion takes place.

1. Turn the camera on.
2. Rotate the mode dial to PLAY mode.
3. Press the MENU button to display the menu on the LCD monitor.
4. Press the UP (▲) / DOWN (▼) button and select [DELETE ALL].
5. Shift the cursor to the [DELETE ALL] sub menu by pressing the RIGHT (►) button.
6. Select the desired sub menu by pressing the UP (▲) / DOWN (▼) button and then press the OK button.
7. Selecting YES or NO.
 - Selecting NO : The display is returned to the initial menu, and [DELETE ALL] menu is highlighted. Press the MENU button, and the menu display will no longer show.
 - Selecting YES : [ARE YOU SURE?] message will display. Selecting [NO] makes the menu display return to the initial display. If you select [YES], [WAITING] message will display and all the images are deleted.

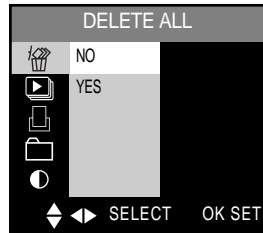

The menu display will return to the initial display. [NO IMAGES] message will be shown by pressing the MENU button.



SETTING UP PLAY BACK FUNCTIONS

SLIDE SHOW

- Images can be displayed continuously at pre-set intervals.

1. Turn the camera power on.
2. Rotate the mode dial to PLAY mode.
3. Do not turn the LCD monitor off.
4. Press the MENU button to display the menu on the LCD monitor.
Press the UP (▲) / DOWN (▼) button and select [SLIDE SHOW].
5. Shift the cursor to the [SLIDE SHOW] sub menu by pressing RIGHT (►) button.
6. Press UP (▲) / DOWN (▼) button and select [START].
7. Press the OK button to start the menu display.
8. To stop the SLIDE SHOW, press the PLAY&PAUSE (►/II) button.

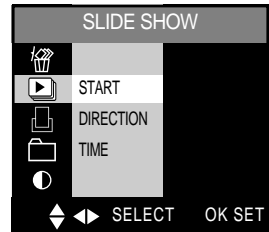

■ Selecting direction

Select SLIDE SHOW DIRECTION

1. Select [DIRECTION] in step 6 by pressing the UP (▲) / DOWN (▼) button.
2. Shift the cursor to the [DIRECTION] sub menu by pressing RIGHT (►) button.
3. Select the desired sub menu by pressing the UP (▲) / DOWN (▼) buttons.
4. After selecting the desired sub menu, press the OK button to confirm the setting.

■ Selecting TIME

- Select SLIDE SHOW delay time.
- You can select 2 SEC, 3 SEC, 5 SEC, 10 SEC delay time.

1. Select [TIME] in step 6 by pressing the UP (▲) / DOWN (▼) button.
2. Shift the cursor to the [TIME] sub menu by pressing RIGHT (►) button.
3. Select the desired sub menu by pressing the UP (▲) / DOWN (▼) buttons.
4. After selecting the desired sub menu, press the OK button to confirm the setting.



SETTING UP PLAY BACK FUNCTIONS

DPOF (Digital Print Order Format)

- DPOF stores printing information onto the CF CARD, enabling you to have images printed directly from the CF CARD.
- Images can then be printed on DPOF printers, or at an increasing number of photo laboratories.
- This function is not adjusted to Movie clip.

QUANTITY

- You can select the number of the printing copies.
1. Turn the camera power on.
 2. Rotate the mode dial to the PLAY mode.
 3. Press MENU button to display the menu on the LCD monitor.
 4. Press UP (▲) / DOWN (▼) button and select [DPOF].
 5. The cursor can be moved by pressing the RIGHT (►) button to the [DPOF] sub menu.
 6. Press UP (▲) / DOWN (▼) button and select [QUANTITY].
 7. Press the RIGHT (►) button, then a menu confirming the number of copies will be displayed.
 - UP (▲) / DOWN (▼) button : selecting the number of copies.
 - RIGHT (►) / LEFT (◀) button : selecting the image that you want to print.
 8. After you select the number of copies, DPOF indicator and the number of copies will be displayed.
 9. Press the OK button to confirm the setting and the initial menu will be displayed.
 10. Press the MENU button to cancel the menu display.





SETTING UP PLAY BACK FUNCTIONS

INDEX

- The images are printed as a thumbnail on a page by this function.

1. Turn the camera power on.
2. Rotate the mode dial to the PLAY mode.
3. Press the MENU button to display the menu on the LCD monitor.
4. Press UP (▲) / DOWN (▼) button and select [DPOF].
5. The cursor can be moved by pressing the RIGHT (►) button to the [DPOF] sub menu.
6. Press UP (▲) / DOWN (▼) button and select [INDEX].
7. Press the OK button to confirm the setting, and [ARE YOU SURE?] message will display. Selecting [NO] makes the menu display return to the initial display. If you select [YES], [WAITING] message will display and the INDEX DPOF function is applied to the stored images.
8. Press the MENU button to cancel the menu display.

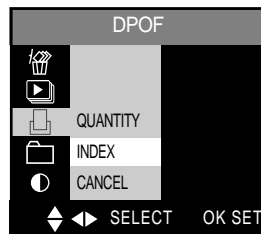



SETTING UP PLAY BACK FUNCTIONS

CANCEL

- This will cancel the STD(standard) and INDEX DPOF function.

1. Turn the camera power on.
2. Rotate the mode dial to the PLAY mode.
3. Press the MENU button to display the menu on the LCD monitor.
4. Press UP (▲) / DOWN (▼) button and select [DPOF].
5. The cursor can be moved by pressing the RIGHT (►) button to the [DPOF] sub menu.
6. Press UP (▲) / DOWN (▼) button and select [CANCEL].
7. Press the OK button and select [INDEX] or [STD] by pressing the UP (▲) / DOWN (▼) button.
8. Press the OK button and [ARE YOU SURE?] message will display.
Selecting [NO] makes the menu display return to the initial display.
If you select [YES], [WAITING] message will display and the [INDEX] or [STD] DPOF function will be cancelled.
9. Press the MENU button to cancel the menu display.

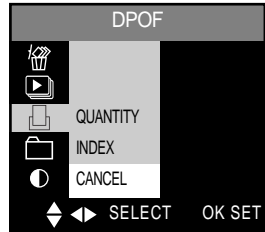



SETTING UP PLAY BACK FUNCTIONS

FOLDER

- Used for changing the folder name to 100SSCAM.
- After changing the folder name, this camera will recognize an image that was taken by another digital camera.

1. Turn the camera power on.
2. Rotate the mode dial to the PLAY mode.
3. Press MENU button to display the menu on the LCD monitor.
4. Press UP (▲) / DOWN (▼) button and select [FOLDER].
5. The cursor can be moved by pressing the RIGHT (►) button to the [FOLDER] sub menu.
6. Press the OK button to change the folder name.

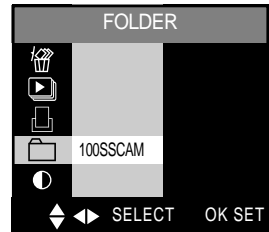

LCD

- You may adjust the LCD brightness.

1. Turn the camera power on.
2. Rotate the mode dial to the PLAY mode.
3. Do not turn the LCD monitor off.
4. Press MENU button to display the menu on the LCD monitor.
Press UP (▲) / DOWN (▼) button and select [LCD].
5. Press the RIGHT (►) button to select [BRIGHTNESS].
6. The cursor can be moved by pressing the RIGHT (►) button to the [BRIGHTNESS] sub menu.
7. Select the desired sub menu by pressing the UP (▲) / DOWN (▼) buttons. The LCD monitor has 9 brightness settings.
8. After selecting the desired sub menu, press the OK button to confirm the setting.
9. Press the MENU button to cancel the menu display.

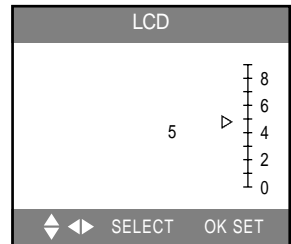



SETTING UP THE CAMERA SYSTEM

Starting SETUP mode

- Rotate the mode dial to SETUP mode, allowing you to set up the basic camera settings.

FORMAT

- This is used for formatting the CF CARD.

1. Turn the camera power on.
2. Rotate the mode dial to the SETUP mode.
3. A menu will display on the LCD monitor.
4. Press UP (▲) / DOWN (▼) button and select [FORMAT].
5. The cursor can be moved by pressing the RIGHT (►) button to the [FORMAT] sub menu.
6. Select the desired sub menu by pressing the UP (▲) / DOWN (▼) buttons.

After selecting the desired sub menu, press the OK button to confirm the setting.

7. - Selecting [NO] : The menu display returns to the initial display.
- Selecting [YES] : [ARE YOU SURE?] message will display. Selecting [NO] makes the menu display return to the initial display. If you select [YES], [WAITING] message will display and the CF CARD is formatted.

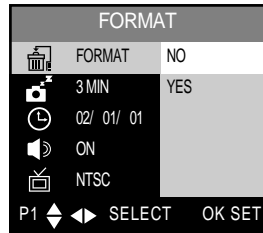

< SETUP mode >

ADVANCED



Note

- All the files in the CF CARD are deleted by [FORMAT] function.
Before formatting the CF CARD, it is advisable to copy important data onto other media as back-up e.g. floppy disks, hard disks, CD etc.







SETTING UP THE CAMERA SYSTEM

POWER OFF

- This function switches the camera off after a set amount of time in order to prevent unnecessary battery drainage.
- You can set the power to switch off at any specified time(1, 3, 5, 10, 30MIN) from the last operation. Note that the automatic power off does not operate if the camera is in slide show or PC mode.

1. Turn the camera power on.
2. Rotate the mode dial to the SETUP mode.
3. A menu will display on the LCD monitor.
4. Press UP (▲) / DOWN (▼) button and select [POWER OFF].
5. The cursor can be moved by pressing the RIGHT (►) button to the [POWER OFF] sub menu.
6. Select the desired sub menu by pressing the UP (▲) / DOWN (▼) buttons. The default is 3MIN.
7. After selecting the desired sub menu, press the OK button to confirm the setting.

POWER OFF		
	FORMAT	1 MIN
	3 MIN	3 MIN
	02/ 01/ 01	5 MIN
	ON	10 MIN
	NTSC	30 MIN
P1	SELECT	OK SET



SETTING UP THE CAMERA SYSTEM

DATE / TIME

- This alters the time and date stored with the images.
- The DATE / TIME will only be displayed on the LCD monitor.
When you print the image, the DATE / TIME will not be printed.
- Range : 2002~2100 year (leap years and months are corrected automatically).
- The default is 2002/01/01 00:00
- You will need to check and select the correct Date / Time when : The camera is used for the first time. The batteries have been removed.

1. Turn the camera power on.
2. Rotate the mode dial to the SETUP mode.
3. A menu will display on the LCD monitor.
4. Press UP (▲) / DOWN (▼) button and select [DATE/TIME].
5. Move to [DATE / TIME] sub menu by using the RIGHT button (►) on the 5-function button.

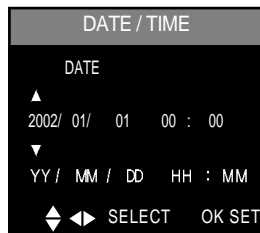

ADVANCED

- Selecting DATE
In step 5, select [DATE] by pressing UP (▲) / DOWN (▼) button and press OK button.
 - Selecting TIME
In step 5, select [TIME] by pressing UP (▲) / DOWN (▼) button and press OK button.
6. To select YEAR/ MONTH / DAY or HOUR / MINUTE, press LEFT (◀) / RIGHT (▶) button. To change the numbers, press UP (▲) / DOWN (▼) button.
 7. Press the OK button to confirm the setting at the [DAY] or [MINUTE] sub menu.



Note

- The DATE and TIME will be displayed on the lower end of the LCD monitor in PLAY mode.
- The DATE and TIME will not be displayed in SHOT mode and will not printed.



SETTING UP THE CAMERA SYSTEM

BEEP

- A beep will sound when you press the camera button.

1. Turn the camera power on.
2. Rotate the mode dial to the SETUP mode.
3. A menu will display on the LCD monitor.
4. Press UP (▲) / DOWN (▼) button and select [BEEP].
5. The cursor can be moved by pressing the RIGHT (►) button to the [BEEP] sub menu.
6. Select the desired sub menu by pressing the UP (▲) / DOWN (▼) buttons. The default is ON.
7. After selecting the desired sub menu, press the OK button to confirm the setting.

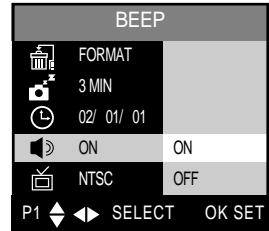



SETTING UP THE CAMERA SYSTEM

VIDEO OUT

- The video output signal from the camera can be NTSC or PAL. Your choice of output will be governed by the type of machine (monitor or TV, etc.) to which the camera is connected.
 - Select the correct video standard for the outer monitor. PAL mode can support only BDGHI.
1. Turn the camera power on.
 2. Rotate the mode dial to the SETUP mode.
 3. A menu will display on the LCD monitor.
 4. Press UP (▲) / DOWN (▼) button and select [VIDEO OUT].
 5. The cursor can be moved by pressing the RIGHT (►) button to the [VIDEO OUT] sub menu.
 6. Select the desired sub menu by pressing the UP (▲) / DOWN (▼) buttons. The default is NTSC.
 7. After selecting the desired sub menu, press the OK button to confirm the setting.
The camera will be restarted.

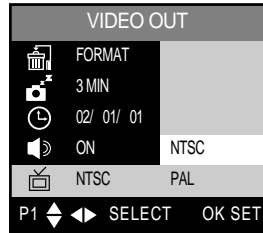

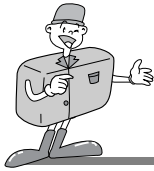

SETTING UP THE CAMERA SYSTEM

LANGUAGE

- There is a choice of languages that can be displayed on the LCD monitor.

1. Turn the camera power on.
2. Rotate the mode dial to the SETUP mode.
3. A menu will display on the LCD monitor.
4. Press UP (▲) / DOWN (▼) button and select [LANGUAGE].
5. The cursor can be moved by pressing the RIGHT (►) button to the [LANGUAGE] sub menu.
6. Select the desired sub menu by pressing the UP (▲) / DOWN (▼) buttons.
7. After selecting the desired sub menu, press the OK button to confirm the setting.

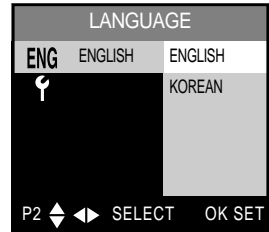



SETTING UP THE CAMERA SYSTEM

RESET

- This menu allows you to reset all the camera settings to the default.

1. Turn the camera power on.
2. Rotate the mode dial to the SETUP mode.
3. A menu will display on the LCD monitor.
4. Press UP (▲) / DOWN (▼) button and select [RESET].
5. The cursor can be moved by pressing the RIGHT (►) button to the [RESET] sub menu.
6. Select the desired sub menu by pressing the UP (▲) / DOWN (▼) buttons.

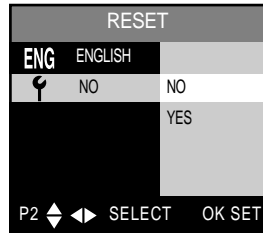

- Selecting [NO] : The menu display returns to the initial display.
- Selecting [YES] : [ARE YOU SURE?] message will display. Selecting [NO] makes the menu display return to the initial display. If you select [YES], the camera setting is returned to the default.



SETTING UP THE CAMERA SYSTEM

< TABLE 1 > List of menu and sub menu

- Remarks ⊙ : Default. x : There is no associated menu.
 ○ : The setting is maintained even if the power button is turned off.
 ◇ : The setting is returned to default, once the camera power has been switched off.
 △ : The setting is returned to default after the function has been completed.

Main menu	Sub menu					SET	
SHOOTING	SINGLE	⊙	⊙	x	x	x	x
	CONTINUOUS	△	△	x	x	x	x
FOCUSING	CENTRAL	⊙	⊙	x	x	x	x
	SPOT	◇	◇	x	x	x	x
FLASH	AUTO&RED EYE	⊙	◇	x	x	x	x
	SLOW SYNCH	◇	◇	x	x	x	x
	AUTO	◇	◇	x	x	x	x
	Fill in	◇	◇	x	x	x	x
	OFF	◇	⊙	⊙	x	x	x
SIZE	LARGE	⊙	⊙	x	x	x	x
	MEDIUM	○	○	x	x	x	x
	SMALL	○	○	x	x	x	x
QUALITY	SUPER FINE	○	○	x	x	x	x
	FINE	⊙	⊙	x	x	x	x
	NORMAL	○	○	x	x	x	x
WHITE BALANCE	AUTO	⊙	⊙	x	x	x	x
	DAYLIGHT	◇	◇	x	x	x	x
	FLUORESCENT	◇	◇	x	x	x	x
	TUNGSTEN	◇	◇	x	x	x	x
EV	+0.2 EV	◇	◇	x	x	x	x
	0.0 EV	⊙	⊙	x	x	x	x
	-2.0 EV	◇	◇	x	x	x	x
METERING	FULL	⊙	⊙	x	x	x	x
	CENTRAL	◇	◇	x	x	x	x
	SPOT	◇	◇	x	x	x	x
ISO	Auto	⊙	⊙	x	x	x	x
	200	◇	◇	x	x	x	x
	400	◇	◇	x	x	x	x



SETTING UP THE CAMERA SYSTEM

SHARPNESS	SOFT	◇	◇	x	x	x	x
	NORMAL	◎	◎	x	x	x	x
	HARD	◇	◇	x	x	x	x
FOUNDER		x	x	x	△	x	x
LCD BRIGHTNESS	9	○	○	x	x	x	x
	5	◎	◎	x	x	x	x
	0	○	○	x	x	x	x
REC. TIME	30 SEC	x	x	◇	x	x	x
	15 SEC	x	x	◎	x	x	x
	05 SEC	x	x	◇	x	x	x
VOICE	ON	x	x	x	△	x	x
	OFF	x	x	x	◎	x	x
SELF TIMER	ON	△	△	x	x	x	x
	OFF	◎	◎	x	x	x	x
LANDSCAPE	ON	◇	x	x	x	x	x
	OFF	◎	x	x	x	x	x
DELETE ALL		x	x	x	△	x	x
SLIDE SHOW		x	x	x	△	x	x
DPOF	QUANTITY	x	x	x	◇	x	x
	INDEX	x	x	x	◇	x	x
	CANCEL	x	x	x	◇	x	x
FORMAT		x	x	x	△	x	x
POWER OFF	1 MIN	x	x	x	x	○	x
	3 MIN	x	x	x	x	◎	x
	5, 10, 30 MIN	x	x	x	x	○	x
DATE / TIME	DATE	x	x	x	x	◎	x
	TIME	x	x	x	x	◎	x
BEEP	ON	x	x	x	x	◎	x
	OFF	x	x	x	x	○	x
VIDEO OUT	NTSC	x	x	x	x	◎	x
	PAL	x	x	x	x	○	x
LANGUAGE	ENGLISH	x	x	x	x	◎	x
	KOREAN	x	x	x	x	○	x
RESET	NO	x	x	x	x	◎	x
	YES	x	x	x	x	△	x

※ Menus are subject to change without prior notice.



CONNECTING TO AN EXTERNAL MONITOR

Connecting to an external monitor

- In PLAY mode, you can view the stored images or movie clips by connecting the camera to an external monitor via the video cable. When the camera is connected to an external monitor, the LCD monitor will be turned off automatically.
- ☞ When the camera is connected to an external monitor, the menu will be visible on the external monitor and the menu functions are the same as those indicated on the LCD monitor.
- Selecting the Video output type
 - You can select an NTSC or PAL video output signal, depending on the external equipment (monitor or TV) that you wish to connect to.
 - ☞ Refer to page 69 [VIDEO OUT] about selecting the video output from the camera.



Reference

- When using a TV as an external monitor, you will need to select the external or AV channel of the TV.
- There will be a digital noise on the external monitor, but it is not a malfunction.
- If the image is not in the centre of the screen, use the TV controls to centre it.



PC MODE

Functions of PC mode

Downloading stored images

- Once you have downloaded images to your PC, they can be edited and printed.
 - (1) Rotate the mode dial to PC mode, and turn the camera on.
 - (2) Connect the camera to your PC with the USB cable.
 - (3) On your computer's desktop display, select [My computer] and double click [Removable Disk]. The image files will then be displayed. Use the COPY or MOVE function to download the images to your PC.
 - (4) By using [Digimax Viewer], you can see the stored images in the CF CARD directly on the PC monitor and you can copy or move the image files.
 - (5) If you wish to edit downloaded images, you can use [MGI PhotoSuite III SE].
- ※ Refer to the software manual part(page 92, 98) regarding editing software installation and usage.
- In this mode, you can download stored images to your PC through the USB cable.
- There is no menu in the PC mode.
- When you connect the camera to a PC, ensure that the mode dial is set on PC mode ().
- The Auto focus indicator(green) lamp blinks when the files are transferring via the USB connection.



Note

- The USB Storage Driver must be installed before using PC mode.
Refer to page 86 regarding installation.
- To save battery power, it is recommended that you use an AC adaptor(Optional) when connecting the camera to a computer.



IMPORTANT NOTES

Caution!

- ▶ Your new Samsung camera is a precision instrument. Whilst it is designed to withstand general wear and tear, there are some important points that will help you get maximum service and reliability from your camera.

The following should be avoided :

- Severe changes in temperature and humidity.
 - Dust and dirt.
 - Direct sunlight or the inside of a vehicle in hot weather.
 - Environments where there is high magnetism or excessive vibration.
 - Areas with high explosives or highly flammable materials.
 - Pesticides, etc.
- ▶ Sand can be particularly troublesome to cameras.
 - Sand or other small particulates can cause severe malfunctions.
Ensure that there is no contact with sand or similar particles.
 - ▶ Extremes in temperature may cause problems.
 - If the camera is transferred from a cold to a warm and humid environment, condensation can form on the delicate electronic circuitry. If this occurs, turn the camera off and wait for at least 1 hour until all moisture is dispersed. Moisture build up can also occur in CF CARD. If this happens, turn off the camera and remove the CF CARD.
Wait until the moisture has dispersed.



IMPORTANT NOTE

- ▶ If the digital camera is not used for a long period, an electric discharge can occur. It is a good idea to remove the batteries and CF CARD if the camera is not used for some time.
- ▶ If the camera is exposed to electronic interference, it will turn itself off to protect the CF CARD.
- ▶ Maintenance
 - Use a soft brush (available from photo stores) to GENTLY clean the lens and LCD assemblies. If this does not work, lens-cleaning paper with lens cleaning fluid can be used.
 - Clean the camera body with a soft cloth. Do not allow this camera to come into contact with solvent materials such as benzol, insecticide, thinners etc.
This may damage the body shell of the camera and also affect its performance.
 - Rough handling can damage the LCD monitor. Take care to avoid damage and keep the camera in its protective carry case at all times.
- ▶ DO NOT attempt to disassemble or modify the camera. It contains delicate parts and there are high voltage circuits that can cause electric shocks.
- ▶ Under certain conditions, static electricity can cause the flash unit to fire.
This is not harmful to the camera and is not a malfunction.
- ▶ When images are uploaded or downloaded, the data transfer may be affected by static electricity. In this case, disconnect and re-connect the USB cable before trying the transfer again.



IMPORTANT NOTE

Warning indicator

. There are several warnings that may appear in the LCD display :

Warning message	Reason for message	Remedy
NO CARD	<ul style="list-style-type: none">• No CF CARD.• The camera cannot recognize the CF CARD.	<ul style="list-style-type: none">• Insert a CF CARD.• Remove and re-insert the CF CARD.• Turn the camera off, wait a few seconds and turn it on again.
NO IMAGES	<ul style="list-style-type: none">• There are no images stored on the CF CARD.	<ul style="list-style-type: none">• Take images.• Insert a CF CARD that is holding some images.
CARD FULL	<ul style="list-style-type: none">• There is insufficient memory capacity to take an image.	<ul style="list-style-type: none">• Insert a new CF CARD, or delete stored images to free up some memory.



BEFORE CONTACTING A SERVICE CENTER

Please check the following

Symptom	Cause	Remedy
The camera doesn't switch on.	<ul style="list-style-type: none"> • There is low battery capacity. • AC Power Adapter is not connected. 	<ul style="list-style-type: none"> • Insert fresh batteries. • Connect AC Power Adapter.
The camera powers down whilst in use.	<ul style="list-style-type: none"> • The batteries are exhausted. • Camera is turned off automatically due to the Auto power function. • Adapter plug is not connected securely. 	<ul style="list-style-type: none"> • Insert fresh batteries. • Press power switch to re-activate camera. • Remove and re-insert plug.
Batteries drain quickly.	<ul style="list-style-type: none"> • Camera being used in low temperatures. • Mixing old and new batteries or battery types. 	<ul style="list-style-type: none"> • Keep camera in warm conditions (i.e. inside a coat or jacket) and only remove it in order to take images. • Insert fresh batteries (all of which should be of the same type)
Camera does not take images when pressing the Shutter button.	<ul style="list-style-type: none"> • CF CARD is not inserted • The CF CARD has not been formatted. • The CF CARD is full. • The camera power is off. • The batteries are exhausted • The mode dial is positioned incorrectly. 	<ul style="list-style-type: none"> • After turning the camera off, insert card. • Format the card. • Insert new CF CARD. • Turn the camera power on. • Insert fresh batteries • Rotate the mode dial to SHOT mode.



BEFORE CONTACTING A SERVICE CENTER

Please check the following

Symptom	Cause	Remedy
The images are unclear.	<ul style="list-style-type: none"> The focus mode is not correct. 	<ul style="list-style-type: none"> If the subject is closer than 0.8m, select MACRO SHOT mode.
The flash does not fire.	<ul style="list-style-type: none"> FLASH OFF mode has been selected. 	<ul style="list-style-type: none"> Dis-engage FLASH OFF mode.
Incorrect date and time is displayed.	<ul style="list-style-type: none"> The date and time have been set incorrectly or the camera has adopted the default settings. 	<ul style="list-style-type: none"> Reset the date and time correctly. Refer to page 67.
The camera buttons do not operate.	<ul style="list-style-type: none"> Camera malfunction 	<ul style="list-style-type: none"> Remove /re-insert batteries and switch camera on.
CF CARD error.	<ul style="list-style-type: none"> Incorrect CF CARD format 	<ul style="list-style-type: none"> Re-format the CF CARD. Refer to page 65.
Color of image different to original scene.	<ul style="list-style-type: none"> WHITE BALANCE setting is incorrect. 	<ul style="list-style-type: none"> Select appropriate WHITE BALANCE. Refer to page 44.
Images are too bright.	<ul style="list-style-type: none"> Exposure is excessive. 	<ul style="list-style-type: none"> Reset exposure compensation. Refer to page 46.



BEFORE CONTACTING A SERVICE CENTER

Symptom	Cause	Remedy
The play back display is not very clear	<ul style="list-style-type: none"> The lens or LCD monitor is smudged or dirty. 	<ul style="list-style-type: none"> Clean the lens or LCD
No image on external monitor	<ul style="list-style-type: none"> The external monitor has not been connected properly with the camera. There are incorrect files in the CF CARD. 	<ul style="list-style-type: none"> Check the connection cables. Insert CF CARD that has correct files.
When using the PC's explorer, 'Removable Disk' file does not show.	<ul style="list-style-type: none"> Cable connection is incorrect. The camera is off. There are no batteries, the batteries are exhausted or the AC adapter is not connected. The operating system is not Windows 98, 98SE, 2000, ME, XP. Alternatively the PC does not support USB. USB driver is not installed. The mode dial is not set on PC mode. 	<ul style="list-style-type: none"> Check the connection. Turn the camera on. Insert new batteries or check the adapter connection. Install Windows 98, 98SE, 2000, ME, XP to PC that supports USB. Install "USB Storage Driver" Rotate the mode dial to PC mode



SPECIFICATIONS

Image Sensor	Type	1/1.8" CCD
	Effective Pixels	Approx. 4.0 (Digimax 340 : 3.2) Mega pixels
	Total Pixels	Approx. 4.1 (Digimax 340 : 3.3) Mega pixels
Lens	Focal Length	SHD Lens f = 7.0 ~ 21.0mm (35mm film equivalent : 34 ~ 102mm)
	F No.	F2.6 ~ F4.5
	Digital Zoom	STILL IMAGE/MACRO SHOT mode : 2X PLAY mode : 2X
Viewfinder	Optical Viewfinder	Real image optical viewfinder
	LCD Monitor	1.6" color TFT LCD
Focusing	Type	TTL autofocus (Central / Spot)
	Range	Normal : 0.8m ~ infinity Macro shot : 0.2 ~ 0.8m
Shutter	Type	Mechanical and Electronic shutter
	Speed	2 ~ 1/2,000 sec.
Exposure	Control	Program AE (Full / Central / Spot)
	Compensation	±2EV (0.5EV steps)
	ISO Equivalent	Auto, 200, 400
Flash	Modes	Auto & Red - eye reduction / Slow sync / Auto / Fill-in flash / Flash off
	Range	Wide : 0.5 ~ 3.0m, Tele : 0.5 ~ 2.0m
	Recharging Time	Approx. 7 sec.
Sharpness		Soft / Normal / Hard
White Balance		Auto / Daylight / Fluorescent / Tungsten
Voice memo		Voice recording and play back for still image
Shooting	Still image /Macro shot	Modes : Single / Continuous
	Movie Clip	Size : 320x240 Recording time : 5 ~ 30 sec. (5sec. steps)
Self-timer		10 sec.
Storage	Media	CompactFlash™ card (Up to 512MB guaranteed)
	File Format	Still image/Macro shot : JPEG (DCF), DPOF Movie Clip : AVI (MJPEG)
	Image Size	D-410 L : 2272x1704 pixels, M : 1600x1200 pixels, S : 640x480 pixels D-340 L : 2048x1536 pixels, M : 1024x768 pixels, S : 640x480 pixels



SPECIFICATIONS

ADVANCED

Capacity (16/32MB)	D-410 Large : Super fine 6/12, Fine 12/25, Normal 25/51 Medium : Super fine 12/25, Fine 25/51, Normal 51/103 Small : Super fine 77/155, Fine 124/249, Normal 182/366 D-340 Large : Super fine 8/17, Fine 12/25, Normal 19/38 Medium : Super fine 19/38, Fine 38/77, Normal 77/155 Small : Super fine 77/155, Fine 124/249, Normal 182/366 * These figures are measured under Samsung's standard conditions and may vary depending on shooting conditions and camera settings.
Image Play	Single image/ Thumbnails / Slide show
Interface	• Digital output connector : USB • DC power input connector : 6.0V • Video output : NTSC / PAL (user selectable) • Audio : Mono
Power Source	• 4 x AA alkaline / 4 x Ni-MH batteries • AC adapter (optional)
Dimensions (WxHxD)	118.7x66.5x50mm / 4.7x2.6x2.0 in
Weight	245g / 8.6oz (without batteries and card)
Software	Camera Driver
	Storage Driver (Windows98/98SE/2000/ME/XP, Mac OS 9.0~10.1.3) Application
	MGI PhotoSuite, Digimax Viewer

System Requirements	Digimax 410 / Digimax 340
For Windows	PC with processor better than MMX Pentium 233MHz (XP : Pentium II 300MHz) Windows 98/98SE/2000/ME/XP Minimum 32MB RAM (XP : 128MB) 110MB of available hard-disk space USB port CD-ROM drive 800 x 600 pixels, 16-bit color display compatible monitor (24-bit color display recommended)
For Macintosh	Power Mac G3 or later Mac OS 9.0~10.1.3 Minimum 32MB RAM 110MB of available hard-disk space USB port CD-ROM drive QuickTime 4.0 or later for Movie Clip

※ Specifications are subject to change without prior notice.



SOFTWARE MANUAL

Please ensure that you read the instruction manual carefully before use

► Software Notes

- The attached software is a camera driver and image editing software tool for Windows.
- Under no circumstances should all or part of either the software or the user manual be reproduced.
- Copyright for the software is licensed only for use with a camera.
- In the unlikely event of a manufacturing fault, we will repair or exchange your camera. We cannot, however, be held responsible in any way for damage caused by inappropriate use.
- Using a Hand-made PC or a PC that has not been guaranteed by a manufacturer is not covered by the Samsung warranty.
- Before reading this manual, you should have a basic knowledge of computers and O/S (Operating Systems).
 - ※ Windows is a registered trademark of Microsoft.
 - ※ Macintosh, Mac is the registered trademark of Apple computer, USA.

About software

► USB Storage Driver

- This camera uses a USB Storage Driver as the camera driver. You can use the camera as a USB card reader. After installing the driver and connecting this camera to the PC, you can find [Removable Disk] in [Windows Explorer] or [My computer].

USB Storage Driver is provided only for Windows.

USB Driver for MAC is not included with the Application CD. But you can use the camera with Mac OS 9.0~10.1.3.

► Digimax Viewer

- You can view the stored images in the CF CARD directly on the PC monitor. And you can copy, move, delete the image and scale up /downscale the image size with Digimax Viewer. For windows only.

► MGI PhotoSuite III SE

- Image editing program for downloaded images.
For Windows only.



HOW TO SET UP THE SOFTWARE FOR WINDOWS

How to set up the software

- After inserting the CD-ROM provided with this camera into the CD-ROM drive, the following frame is automatically run.



1. Driver : This enables images to transfer between the camera and PC.
 - Driver installation for Windows : refer to page 86
2. Image Viewer : Digimax Viewer. Refer to page 90
3. Application : MGI PhotoSuite SE : image editing program. Refer to page 92.
4. Web Site Link : You can visit the Samsung web-site through the internet.
 - <http://www.samsungcamera.com> : English
 - <http://www.samsungcamera.co.kr> : Korean



Reference

- If you insert application CD for Digimax 340 in the CD-ROM drive, all the 'Digimax 410' text will be changed to 'Digimax 340'
- Check the system requirements (page 83) before setting up the driver.
- You should allow 5~10 seconds for running the automatic setup program according to the capability of the computer. If the frame does not show, run the [Windows Explorer] and select [Samsung.exe] in the CD-ROM Drive root directory.



HOW TO SET UP THE SOFTWARE FOR WINDOWS

Setting up USB driver for Windows

To use this camera with a PC, install the Camera Driver first. After this has been done, the stored images in the camera can be moved to the PC and can be edited by an image editing program.

- 1 Click [Storage Driver] menu on the Autorun frame and the 'Welcome' Window will open. Click [Next >].



- 2 [Storage Driver] installation has started.



- 3 Installation is complete. Restart your computer.





HOW TO SET UP THE SOFTWARE FOR WINDOWS

Setting up USB driver for Windows

4 After restarting the computer, connect the PC to the camera with the USB cable.

5 Turn the camera power on with the mode dial set on PC mode. [Found New Hardware Wizard] will appear and the computer will recognize the camera.

6 USB Driver installation is complete. After installation, [Removable Disk] will be displayed under [My computer] as shown alongside.



Note

- Before connecting the camera to the PC, you must install the camera driver.
- After driver installation, you have to restart the computer.
- If the camera is connected to PC before Driver installation, [Add Found New Hardware Wizard] will appear. In this case, follow [Add Found New Hardware Wizard] to install the camera driver.
When windows search for new drivers in its database on your hard drive, select [Driver Setup] folder by browsing the Application CD.
- Should the computer not find the Camera Driver after installation, please try one or more of the following measures.
 1. Delete the camera driver, and re-install the driver.
 2. Refer to FAQ(refer to page 115) to check for a possible solution to the problem.
- If your PC's central processing unit is VIA Chip (This is shown in the USB Host Controller), download the patch file from the Samsung Camera web page. (<http://www.samsungcamera.com>).



HOW TO SET UP THE SOFTWARE FOR WINDOWS

Setting up DirectX 8.1 for Windows

DirectX is a windows technology that enables higher performance in graphics and sound when you're playing games or watching video on your PC.

1 After driver installation, [Microsoft DirectX 8.1 Setup] window will open automatically. Click [Yes].



2 The software license agreement window will open. If you agree to it, click [Yes]. This will take you to the next step. If you disagree, click [No] and the installation program will be canceled.



3 [DirectX 8.1] installation has started.





HOW TO SET UP THE SOFTWARE FOR WINDOWS

Setting up DirectX 8.1 for windows

4 Your system will be updated.



5 Installation is complete. Restart your computer.





HOW TO SET UP THE SOFTWARE FOR WINDOWS

Setting up Digimax Viewer

This software is only compatible with Windows.

1 Click [Digimax Viewer] on the Autorun frame.

2 The installation window will be displayed as shown alongside. Click [Next].



3 The Software License Agreement window will display. If you agree to it, click [Yes]. This will take you to the next step. If you disagree, click [No] and the installation program will be canceled.



4 Select destination folder and click [Next].





HOW TO SET UP THE SOFTWARE FOR WINDOWS

Setting up Digimax Viewer

5 Select Program folder and click [Next].



6 The setup status window will be displayed.



7 Installation is completed.
If you wish to open this program automatically whenever the camera connects to PC, click [I would like to launch Digimax Viewer] Checkbox. And click [Finish].





HOW TO SET UP THE SOFTWARE FOR WINDOWS

Setting up the MGI PhotoSuite III SE

This software is only compatible with Windows.

1 Click the MGI PhotoSuite III SE menu on autorun frame.

2 Select language.



3 A Welcome window will be displayed. Click [Next >] to move to the next step.



4 The Software License Agreement window will be displayed. If you agree to this, click [Yes], the window will then move to the next step. If you disagree, click [No] and the installation program will be canceled.





HOW TO SET UP THE SOFTWARE FOR WINDOWS

- 5 Select setup type and click [Next]
- Full : the program will be installed with all the options.
- Custom : you can choose what you would like to install.



- 6 Start Copying Files window will be displayed.
- Click [Next >] to start installation.



- 7 The MGI Registration window will be displayed before completing installation.
- Register : send your personal information to MGI for registration.
- Cancel : postpone registration.

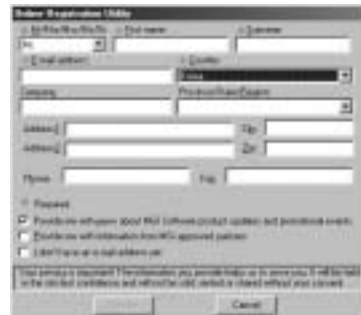



HOW TO SET UP THE SOFTWARE FOR WINDOWS

8 Installation is complete.



- ▶ If installation is completed correctly, Autoplay is registered automatically into the start menu program as shown alongside.





CONNECTING THE CAMERA FOR WINDOWS

Connecting USB cable to the Camera for Windows

- To download images, you will need Windows 98 or later and a USB port on your computer.

- 1 Connect the USB cable to the USB port on the computer.
- 2 Connect the other end of the USB cable to the USB connection terminal on the camera.
- 3 Set the mode dial to PC mode ().
- 4 Switch the camera on.



Removable Disk

- To use this camera as a Removable Disk, install the USB Driver.

- 1 Before turning the camera power on, connect the camera to the PC with the USB cable and rotate the mode dial to PC mode.
- 2 Click [Removable Disk] under [My computer] or [Windows Explorer].
- 3 Image files stored in the Removable Disk can be transferred to the PC.



REMOVABLE DISK



Note

- ▶ Important information whilst using the Removable Disk
 - The [Removable Disk] indicator will not show when the camera power is off.
 - We recommend that you should copy the images to the PC to view them. Opening images directly from the removable disk may be subject to unexpected disconnection.
 - When uploading images from the PC to the camera, ensure that the uploaded file names are not the same as those already stored on the CF CARD.
Files with the same file name but different extensions (e.g : S4100001.jpg/S4100001.avi), JPG file format will appear first. And if the displayed file is deleted, all the same file name images are deleted.
 - When you upload a file that is not taken by this camera to Removable Disk, the ERROR FILE message will be displayed on the LCD monitor in PLAY mode, and nothing is displayed in THUMBNAIL mode.
 - The green lamp next to the viewfinder will blink, when a file is transferred (copy or deletion) between the PC and camera. Do not remove the USB cable or rotate the mode dial until the lamp stops blinking. To remove the USB cable, use the [Unplug or Eject Hardware] icon on the task bar. In Windows 2000, take extra care, as the following may occur.
 1. When an image file from the Removable Disk is deleted : The green lamp will blink for about 10 seconds after file deletion is completed.
 2. When an image file is transferred between PC and Removable Disk : The green lamp will blink again 15-20 seconds after the first time when it blinks.
The work is not completed until the lamp has finished blinking.
 - When uploading the sound recorded image to the camera, you should upload both WAV and JPG files. For example, if you upload S4100001.wav file to the camera, the S4100001.jpg file has to be uploaded too.





HOW TO USE THE SOFTWARE

Digimax Viewer

This software is only compatible with Windows.

To open Digimax Viewer, click the [Start → Programs → Samsung → Digimax Viewer 1.0 → Digimax Viewer 1.0] and Digimax Viewer 1.0 will then open.

- The stored images will be displayed as thumbnail image.
- You can easily copy, move and delete the stored images.



If the Auto Launch option is selected, the program will execute automatically after recognizing the camera.

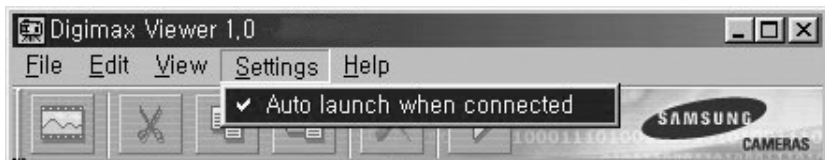

* Refer to [Help] menu in Digimax viewer for further information.



HOW TO USE THE SOFTWARE

MGI PhotoSuite III SE

This software is only compatible with Windows.

To open MGI PhotoSuite III SE, click the [Start → Programs → MGI PhotoSuite III SE → MGI PhotoSuite III SE] and MGI PhotoSuite III SE will then open.











HOW TO USE THE SOFTWARE

MGI PhotoSuite III SE

- An introduction to the Welcome screen









	<p>Get</p> <p>Get images.</p>
	<p>Prepare</p> <p>A number of photo editing activities can be performed within this module.</p>
	<p>Compose</p> <p>Use your photos in a variety of fun, creative and interesting ways.</p>
	<p>Organize</p> <p>Organize your photos and other media files into albums.</p>
	<p>Share</p> <p>Save your results to show to others.</p>
	<p>Print</p> <p>Print hard copies of photos and projects.</p>

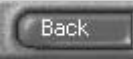
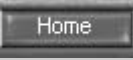

HOW TO USE THE SOFTWARE

◆ Introduction to the navigation bar



	Back Return to the previous step.
	Home Return to Welcome screen.
	Help Display help window.
	Get Get images.
	Prepare A number of photo editing activities can be performed within this module.
	Compose Use your photos in a variety of fun and interesting ways.
	Organize Organize your photos and other media files into albums.
	Share Save your results to show to others.
	Print Print hard copies of photos and projects.
	Browse Browse the web site.



HOW TO USE THE SOFTWARE

MGI PhotoSuite III SE

GET : Get images

- ▶ To obtain images from the computer

1 To acquire images, Click the large [Get] button on the Welcome screen, or the [Get] button on the Navigation bar. Click [Computer] from the list of options displayed on the activity panel.



2 The Open file selector is displayed. Now select the image file and click [open].



3 The Welcome screen will change to the next work step, with the selected image displayed.

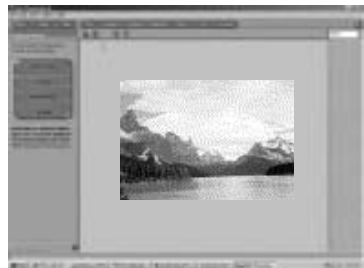



HOW TO USE THE SOFTWARE

MGI PhotoSuite III SE

- ▶ When you obtain images from the digital camera.



Note

- When you connect a PC to the Camera, use the following sequence :
 1. Turn the Mode dial to PC mode.
 2. Turn the power on.
 3. Connect the USB cable.
- ※ Refer to page 95 for more information about connecting the cable.

- 1 To acquire images, click the large [Get] button on the Welcome screen, or the [Get] button on the Navigation bar. Click [Computer] from the list of options displayed on the activity panel.



- 2 The Open file selector is displayed. Click [Look in :] to choose [Removable Disk (:)] and click [open] for the open file window to be displayed.





HOW TO USE THE SOFTWARE

MGI PhotoSuite III SE

- 3 Select [Dcim → 100sscam] folder. Then select image and click [Open].



- 4 The Welcome screen will change to the next work step, with the selected image displayed.

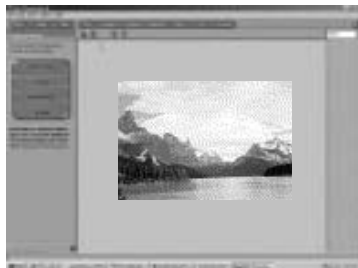

Note

When you use the Digimax camera, only [Computer] and [Album] from the list of options displayed are available. You will be able to obtain images from the digital camera.



[Computer and Album Only]



HOW TO USE THE SOFTWARE

MGI PhotoSuite III SE

► Acquiring images from an Album.

1 To acquire images, click the large [Get] button on the Welcome screen, or the [Get] button on the Navigation bar. Click [Album] from the list of options displayed on the activity panel.

2 After selecting Album on the [① Choose a photo album], click an image in the album and click [Open].

3 The Welcome screen will change to the next work step, with the selected image displayed.

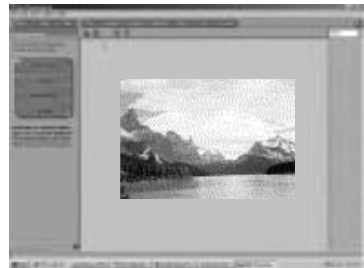

※ Refer to page 108 for more information about creating an Album.



HOW TO USE THE SOFTWARE

MGI PhotoSuite III SE

PREPARE

When the image is loaded, the step changes to Prepare automatically.

■ Menu for the [PREPARE] step

- **Rotate & Crop**

You can rotate, flip or crop images along with a host of others.

- **Touchup**

Remove Red eye, Remove Scratches etc.. are available in this menu.

- **Special Effects**

A number of special effects can be applied.

- **Stitching**

Join a series of photos together to create a sweeping panoramic effect.

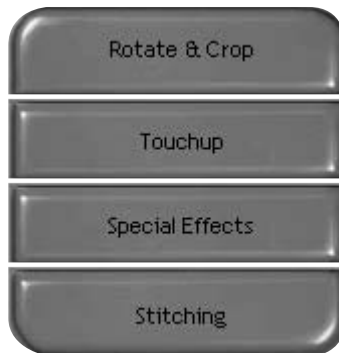



HOW TO USE THE SOFTWARE

MGI PhotoSuite III SE

COMPOSE

Add Text , Compound Images etc.. are available in this step.

■ Menu for the [COMPOSE] steps

- **Collages** : A collage consists of several photos or sections of photos arranged together on a common background.
- **Photo Layouts** : The Photo Layouts activity includes many collage and layout options.
- **Cards & tags** : Use your photos to create items such as Gift Tags, Greeting Cards, Invitations, Postcards, and Sports Cards.
- **Calendars** : Use your photos to create a variety of calendars (monthly, quarterly, seasonal, yearly).
- **Collections** : Photos can also be used to create a variety of items for business purposes.

Add frames and boarder effects to your photos with the predefined templates.





HOW TO USE THE SOFTWARE

MGI PhotoSuite III SE

ORGANIZE

Organize your photos and other media files into albums.

■ Menu for the [ORGANIZE] step

- ① Choose a photo album to view or edit
Select Album : To create an Album, click [Organize] in the welcome screen or navigation bar.
Album.. : Open Master Album.
- ② Select a photo, and choose an action below.
Open : Open selected image.
Delete : Delete selected image.
Properties.. : view image information.
- ③ Choose an action to manage your album.
Add : click [Add] to add an image to an Album.
Sort : click [Sort] to Sort saved images.
Search : click [Search] to Search saved images.
Reset : click [Reset] to reset the setting.
Update : click [Update] to update images.
Create Slide Show.. : click [Create Slide Show] to create a Slide Show.
Always start on this page : If you select this option, the program will start in [Organize].





HOW TO USE THE SOFTWARE

MGI PhotoSuite III SE

► Creating an Album

1 To create an Album, click the large Organize button on the Welcome screen, or the Organize button on the Navigation bar.

2 Click [Album..] in [① Choose a photo album to view or edit.]

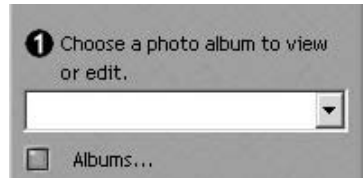

3 The Master Album window will be displayed, then click [New..].



4 Enter a new Album name in the New Album window and click [OK]. A new album will now be created.





HOW TO USE THE SOFTWARE

MGI PhotoSuite III SE

SHARE

► Saving images

1 Saving or sharing images.

■ Menu for the [SHARE] step

• Save

To save the active file according to its current name and path.

• Save As

To assign a new name or path to the file.

• Send E-mail

e-mailing images.

• Slide Show

Viewing images as a slide show.



2 Click [SAVE] and the Save Project window will be displayed. Enter the file name and click [Save] to save an image.



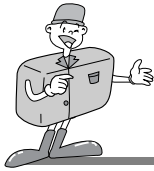

HOW TO USE THE SOFTWARE

MGI PhotoSuite III SE

PRINT

► Printing images

1 You can print images.

■ Menu for the [PRINT] step

. Print

Printing images.

. Print Multiples

Print multiple copies of a photo or project, or one copy of each of the photos included in an album, according to a predefined template.



2 Choose a printer, an orientation, the print size, and the number of copies. You can then print the images.



Reference

For more information, please refer to the Help file in [Help → MGI PhotoSuite III help].



REMOVING THE USB DRIVER FOR WINDOWS

Removing USB Driver for Windows

1 Click [Add/Remove programs] in Controller.



2 After selecting [Samsung Digimax 410], click [Add/Remove] and the following window will be displayed.





REMOVING THE USB DRIVER FOR WINDOWS



Reference

If you are a Windows 2000/ME/XP user, follow the procedure below to remove the USB Driver.

1. Connect the PC to the camera (PC mode, power on)
2. As mentioned above, remove [Samsung Digimax 410] in [Add/Remove programs]
3. Click [Unplug or Eject Hardware] icon on the task bar. Click [Stop] on the [Unplug or Eject Hardware] window and click [Ok] on the next window.



4. Click [System] on Control Panel. Trace [Device Manager → Universal serial bus controller → Samsung USB Mass Storage Device] and click the right mouse button. Then the following window will be displayed. Click [Remove] to remove the USB Driver. Restart the computer





CONNECTING THE CAMERA FOR MAC

Connecting the USB cable to the camera for MAC

- The USB port has to be in the Macintosh or keyboard.

- 1 Connect the USB cable to the USB port on the Macintosh.
- 2 Connect the other end of the USB cable to the USB port of the camera.
- 3 Rotate the mode dial to PC mode ().
- 4 Switch the camera on.





HOW TO INSTALL AND USE THE USB DRIVER FOR MAC

Setting up the USB Driver for MAC

- 1 The USB Driver for MAC is not included with the Application CD as MAC OS support the camera driver.
- 2 Check MAC OS.
This camera is available in MAC OS 9.0~10.1.3.



Note

Before connecting the camera to MAC, check that the CF CARD is inserted in the card slot.

- 3 Connect the camera to the Macintosh and turn the camera power on in PC mode.
- 4 A new icon (Untitled) will be displayed on the desktop after connecting the camera to the MAC.

Using a USB Driver for MAC

- 1 Double click a new icon (Untitled) on the desktop and the folder in the CF CARD will be displayed.
- 2 Select an image file and copy or move it to MAC.

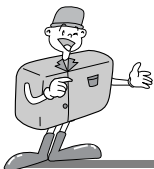

FAQ

About USB

- Please check the following if the USB connection malfunctions.

[Case 1] The camera power is off.

→ Turn the camera power on.

We recommend using an AC power adapter in PC mode. If you use batteries, check the battery condition.

[Case 2] The mode dial is not set to PC mode.

→ Rotate the mode dial to PC mode.

PC interfacing is available only in PC mode.

[Case 3] USB Driver is not installed correctly.

→ Install the USB Driver correctly. Refer to pages 86

[Case 4] The USB cable is not connected or you are using a cable with an incorrect specification.

→ Use a USB cable with the correct specification.

[Case 5] The CF CARD is not inserted or the camera can't recognize the CF CARD.

→ Turn the camera power off and insert the CF CARD again.

[Case 6] Occasionally the computer recognizes the USB as another device.

→ Install the camera driver correctly.

Turn the camera power off and remove the USB cable.

Connect the USB cable again and turn the camera power on.

Then the computer should now recognize the camera.



FAQ

About USB

[Case 7] There is an unexpected error during file transfer.

→ Turn the camera power off and on again. Transfer the file again.

[Case 8] How do I know my computer supports a USB Interface?

→ Check the USB port in your computer or keyboard.

→ Check OS version. USB Interface is available in Windows 98, 98SE, 2000, ME .XP.

→ Check [Universal serial bus controller] in Device Manager.

Do the following to check [Universal serial bus controller].

Win 98/ME : Trace [start → setting → controller → system → Device Manager → Universal serial bus controller].

Win 2K : Trace [start → setting → controller → system → Hardware → Device Manager → Universal serial bus controller].

Win XP : Trace [start → Control Panel → Performance and Maintenance → system → Hardware → Device Manager → Universal Serial Bus controller].

There must be USB Host Controller and USB root hub under [Universal serial bus controller].

→ When all the conditions mentioned above are met, the computer can support the USB interface.

[Case 9] When using USB hub.

→ There may be a problem in connecting the camera to the PC through the USB hub if the PC and the hub are not compatible. Wherever possible, connect the camera to the PC directly.

[Case 10] Are other USB cables connected to the PC?

→ The camera may malfunction when it is connected to the PC at the same time as another USB cable. In this case, disconnect the other USB cable, and connect only one USB cable to the camera.

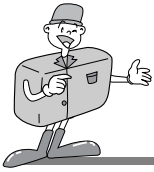

MEMO

SOFTWARE

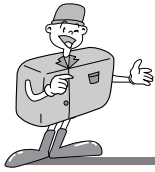

MEMO

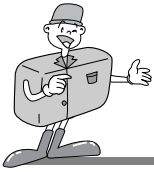

MEMO

SOFTWARE



SAMSUNG TECHWIN CO., LTD.
OPTICS & DIGITAL IMAGING DIVISION
145-3, SANGDAEWON 1-DONG, JUNGWON-
GU, SUNGNAM-CITY, KYUNGKI-DO, KOREA 462-121
TEL : (82) 31-740-8086, 8088, 8090, 8092, 8099
FAX : (82) 31-740-8398, 8399

SAMSUNG OPTO-ELECTRONICS AMERICA, INC.
HEADQUARTERS
40 SEAVIEW DRIVE, SECAUCUS, NJ07094
TEL : (1) 201-902-0347
FAX : (1) 201-902-9342

WESTERN REGIONAL OFFICE
18600 BROADWICK ST.,
RANCHO DOMINGUEZ, CA 90220
TEL : (1) 310-537-7000
FAX : (1) 310-537-1566

SAMSUNG OPTO-ELECTRONICS UK LTD.
SAMSUNG HOUSE, 3 RIVERBANK WAY,
GREAT WEST ROAD, BRENTFORD,
MIDDLESEX, TW8 9RE, U.K.
TEL : (44) 20-8232-3280
FAX : (44) 20-8569-8385

SAMSUNG OPTO-ELECTRONICS GMBH
SAMSUNG HAUS
AM KRONBERGER HANG 6, 65824 SCHWALBACH,
GERMANY
TEL : (49) 6196-66 53 03
FAX : (49) 6196-66 53 66

SAMSUNG FRANCE S.A.S.
BP 51 TOUR MAINE MONTPARNASSE
33, AV. DU MAINE
75755, PARIS CEDEX 15, FRANCE
HOTLINE PHOTO NUMÉRIQUE : (33) 1-44757389
TEL : (33) 1-4279-2282/5
FAX : (33) 1-4320-4510

SAMSUNG TECHWIN MOSCOW OFFICE
KORP. 14 37-A LENNINGRADSKY PRO-KT
MOSCOW, 125167, RUSSIA
TEL : (7) 095-258-9296, 9298, 9299
FAX : (7) 095-258-9297

TIANJIN SAMSUNG OPTO-ELECTRONICS CO., LTD.
7 PINGCHANG ROAD NANKAI DIST., TIANJIN
P.R CHINA
POST CODE: 300190
TEL : (86) 22-2761-8867
FAX : (86) 22-2761-8864

* Internet address - <http://www.samsungcamera.com/>

 The CE Mark is a Directive conformity mark of the European Community (EC)

6806-1260